



Sistema de de Cerramientos de Seguridad  
*Machine Guard System*

# Machine Guard System





Sistema de Cerramientos de Seguridad  
*Machine Guard System*

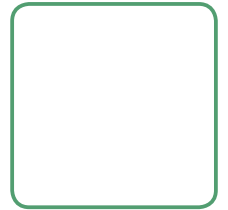
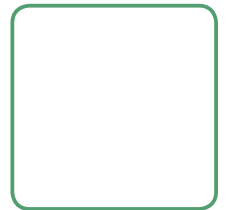
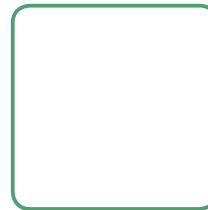
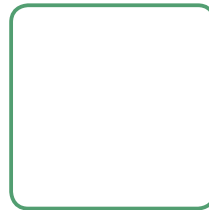
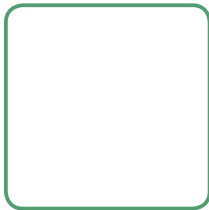
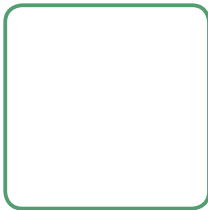
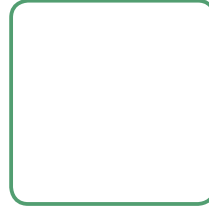
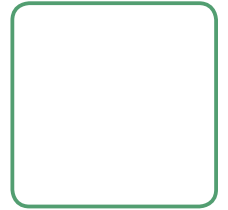
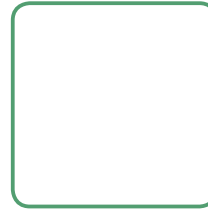
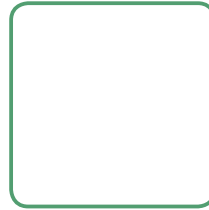

Sistema de Cerramientos de Seguridad  
*Machine Guard System/Safety Fencing System*

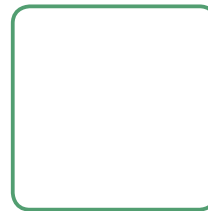
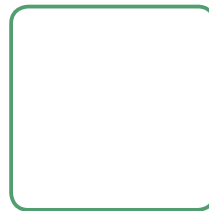
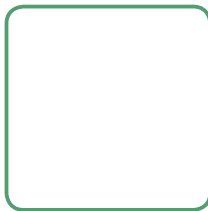
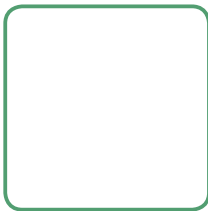
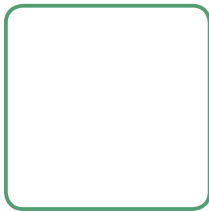
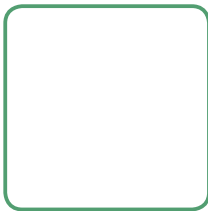
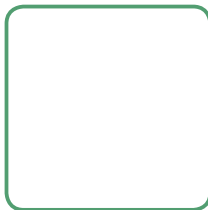
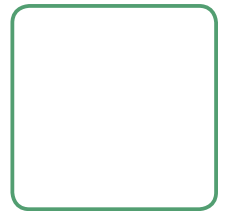

Sistema de Cerramientos de Seguridad  
*Machine Guard System/Safety Fencing System*

Los sistemas MGS están diseñados para cubrir los requerimientos de seguridad alrededor de máquinas y equipos. Los diversos tipos de perfiles y conectores permiten la instalación de rejillas, paneles PMMA, paneles de aluminio compuesto, y otros.

*The MGS systems are designed to meet the mandatory safety requirements around machinery and equipment. The different profiles and fastening elements allow the installation of wire mesh, PMMA panels, aluminium composite panels, and others.*

- Norma de diseño / *Design Standard:*  
- Australian and NZ AS 4024.1-2014 Series Safety of Machinery.

Especificación básica del producto / *Basic Product Spec:*

- Profiles: T-Slot Extruded Aluminium Profile 6063-T5 with anodizing layer  $\geq 11$  microns;
- Profile Finishing: Etching finishing (provides uniform surface; hides extrusion lines and imperfections);
- Accessories: Die Cast Aluminum (standard), Die Cast Aluminum with Chemical Oxidation Process (optional);
- Sheetmetal Accessories: Zinc Plated Steel (standard), SS (optional);
- Fasteners: Nickel Plated Steel (standard), SS (optional).

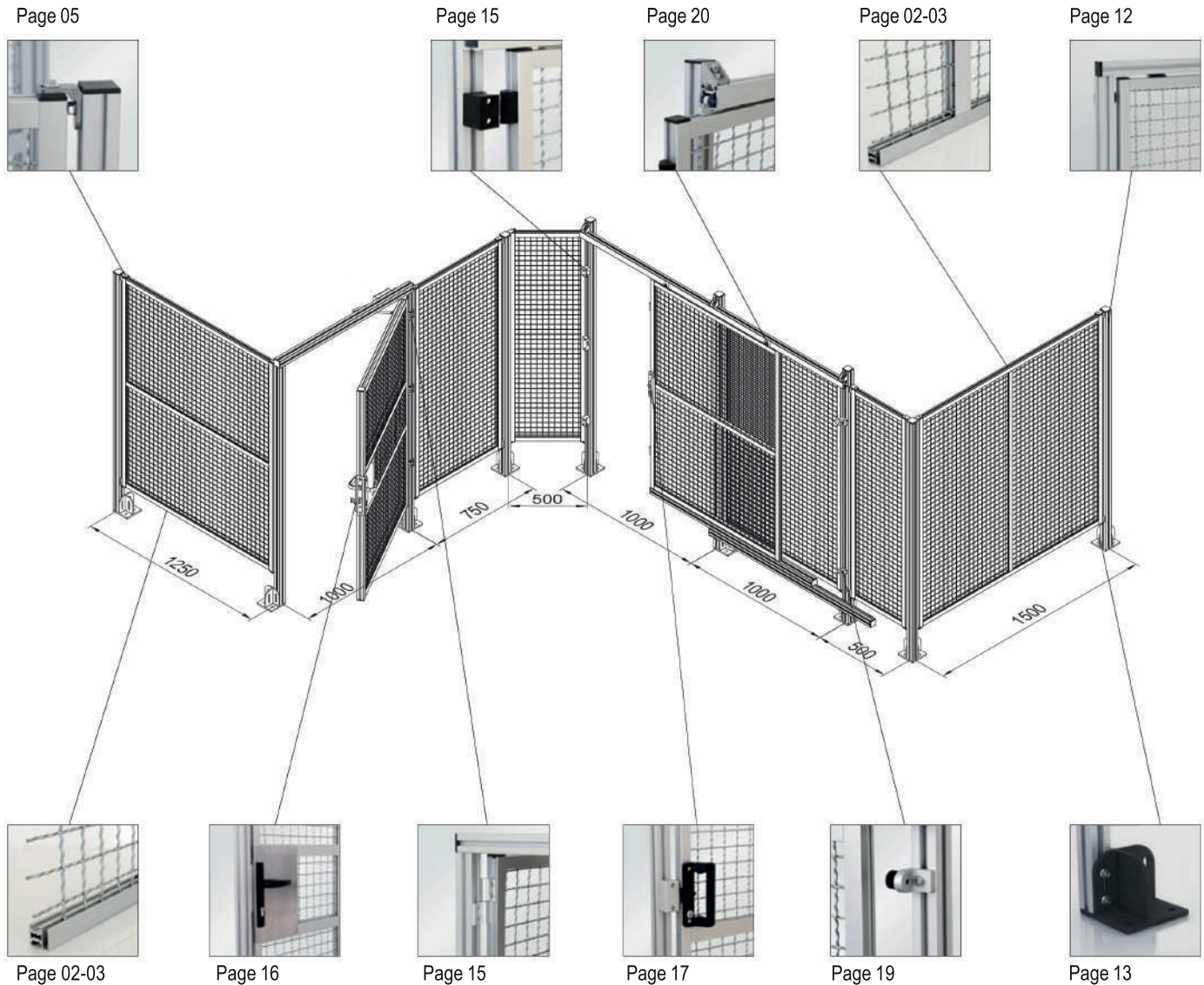

Indice de Productos / Product Index



Panels  
Page 02-03

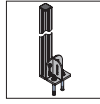

Strut Elements  
Page 04

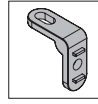

Connecting  
Elements Page 05



Swing Door  
Components Page 06



Sliding Door Components  
Page 07

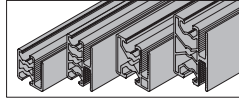

Protective Grille  
Profile Page 08

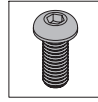

Bolt Connector  
Page 09

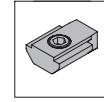

Anti-torsion Subsequent Nut  
Page 09

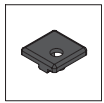

End Cap for Protective Grille  
Profile Page 09

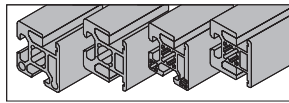

Clamping Profile  
Page 10

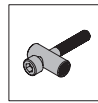

Bushing  
Page 11

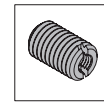

Hole Reducer Bolt  
Page 11

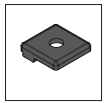

End Cap for Clamping Profile  
Page 11

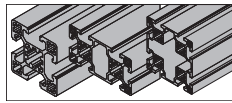

Strut Profile for PG40  
Page 12



Base Plate  
Page 13

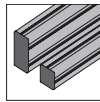

Profile Accessories  
Page 14

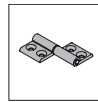

Hinge for Swing Door  
Page 15

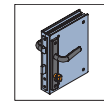

Lock for Swing Door  
Page 16

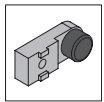

Buffer Block for Swing Door  
Page 16

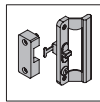

Lock for Sliding door  
Page 17

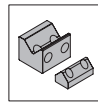

Guide Block for Sliding Door  
Page 18

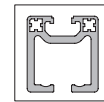

Profile Rail  
Page 19

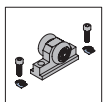

Pulley Block for Sliding Door  
Page 19

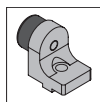

Buffer Block for Sliding door  
Page 19

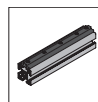

Friction Strip components  
Page 20

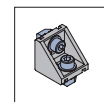

Die Cast Bracket  
Page 20

Componentes del Cerramiento de Seguridad  
Safety Fencing System Components



Page 04

+



Page 02-03

+

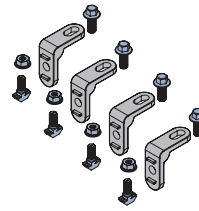

Page 05

=

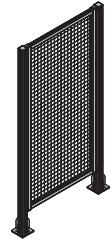

+



Page 02-03

+



Page 04

+

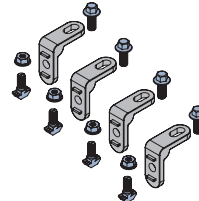

Page 05

=

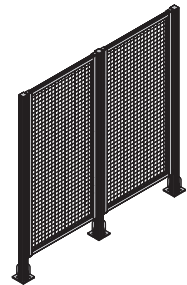

Page 04

+

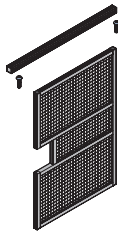

Page 06

+

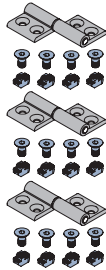

Page 15

+



Page 16

+



Page 16

=

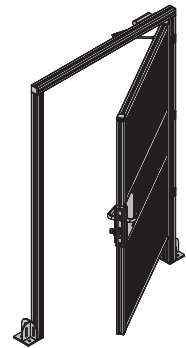

Page 04

+

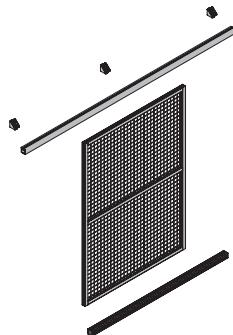

Page 07

+

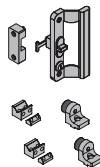

Page 17-18

+

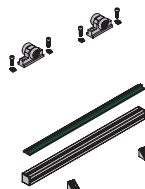

Page 19-20

=

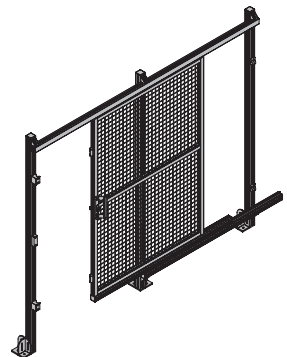

Selección del tipo de Panel  
Panel Type Selection

PG30 Type A1: Mesh 40x40 D4mm  
Application Range  $280 \leq W \leq 1080$   
 $400 \leq H \leq 2100$

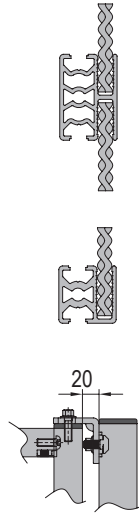
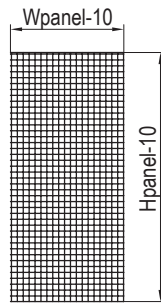
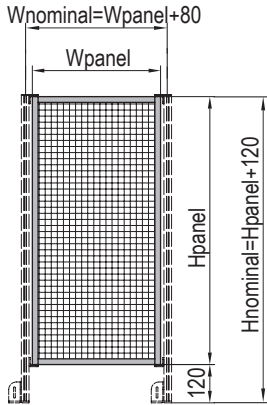

PG30 Type A2: Mesh 40x40 D4mm  
Application Range  $280 \leq W \leq 1080$   
 $2100 < H \leq 3600$

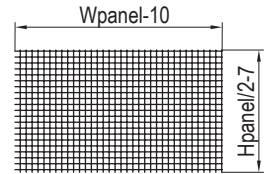
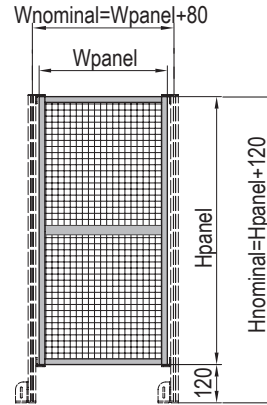

\* El Panel no incluye los Elementos Estructurales (Postes).  
The Panel section does not include the Strut Elements (Posts).

PG30 Type B1: Mesh 40x40 D4mm  
Application Range  $1080 < W \leq 1580$   
 $400 \leq H \leq 2100$

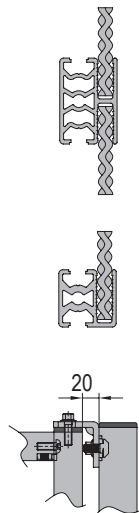
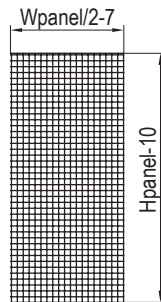
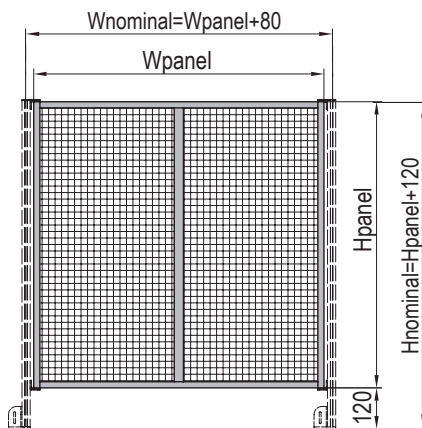

PG30 Type B2: Mesh 40x40 D4mm  
Application Range  $1080 < W \leq 1580$   
 $2100 < H \leq 3600$

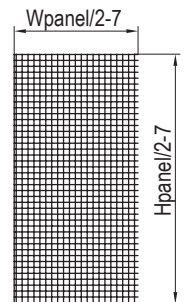
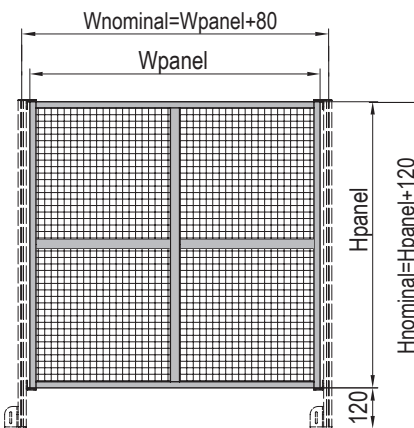

\* El Panel no incluye los Elementos Estructurales (Postes).  
The Panel section does not include the Strut Elements (Posts).

Selección del tipo de Panel  
Panel Type Selection

PG30 Type A1: Transparent PMMA Thk.4mm  
Application Range  $280 \leq W \leq 1080$   
 $400 \leq H \leq 2100$

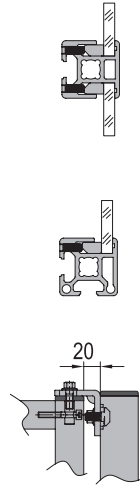
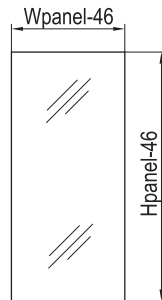
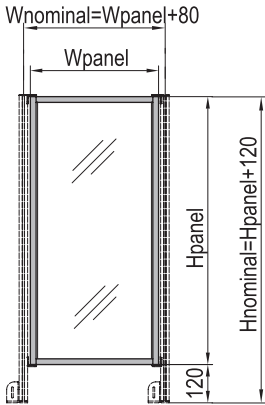

PG30 Type A2: Transparent PMMA Thk.4mm  
Application Range  $280 \leq W \leq 1080$   
 $2100 < H \leq 3600$

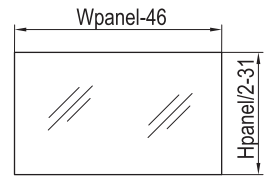
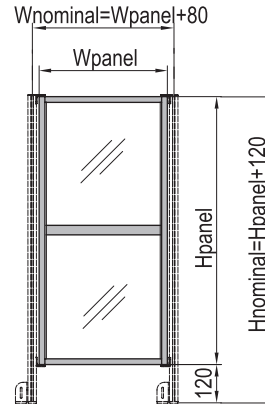

\* El Panel no incluye los Elementos Estructurales (Postes).  
The Panel section does not include the Strut Elements (Posts).

PG30 Type B1: Transparent PMMA Thk.4mm  
Application Range  $1080 < W \leq 1580$   
 $400 \leq H \leq 2100$

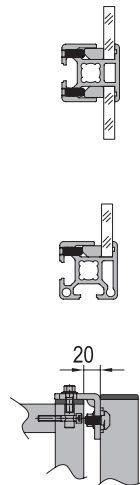
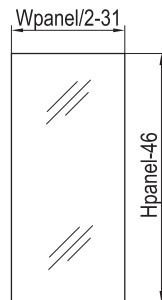
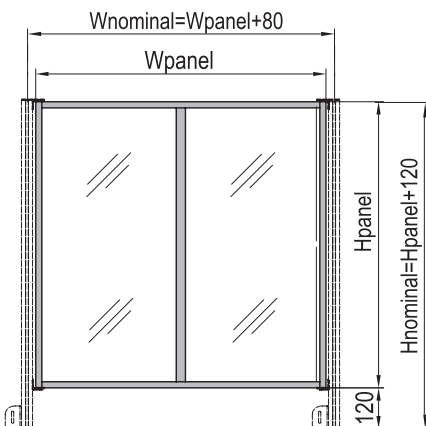

PG30 Type B2: Transparent PMMA Thk.4mm  
Application Range  $1080 < W \leq 1580$   
 $2100 < H \leq 3600$

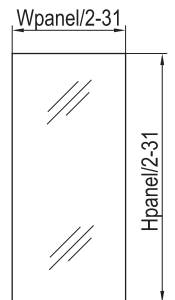
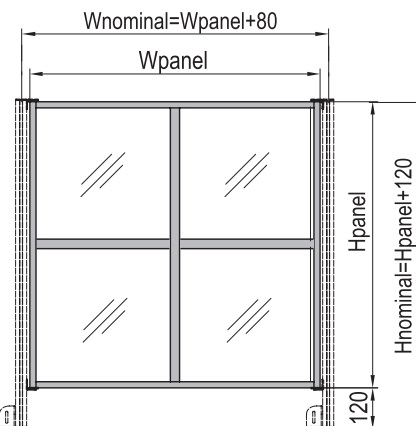

\* El Panel no incluye los Elementos Estructurales (Postes).  
The Panel section does not include the Strut Elements (Posts).



Elementos Estructurales  
Strut Elements

A: Elemento Estructural  
A: *Strut Profile*

B: Tapa  
B: *End Cap*

C: Platina de Anclaje  
C: *Base Plate*

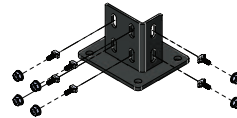
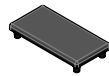
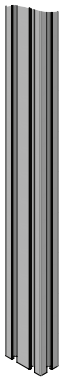

\* La Platina de Anclaje no incluye tacos de expansión.  
*The Base Plate does not include the expansion bolts.*

Conjunto para Elemento Estructural  
Strut Element Group

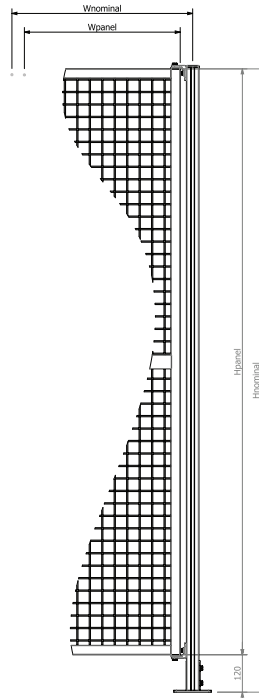
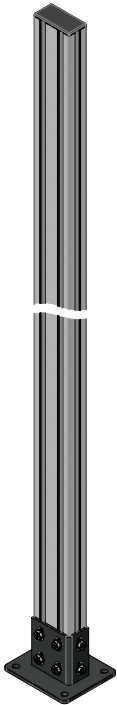

**Elementos de Conexión**  
*Connecting Elements*

Para conectar los paneles a los Elementos Estructurales (Parantes).  
*To connect protective fences with the Strut Elements (Posts).*

Material: Fundición de Zinc  
*Die Cast Zinc*

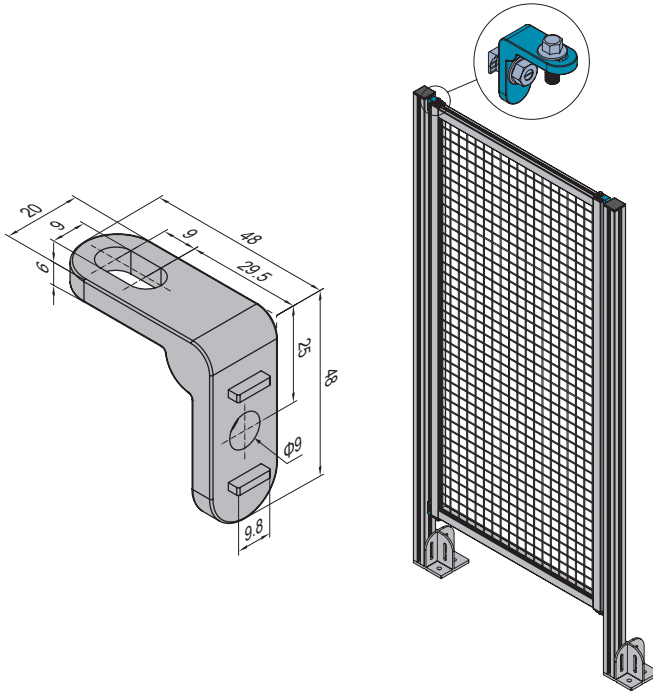

Descripción		Fastening Set	Masa (g)	Part No.
Net Group	Connecting Element for PG30	1×HA	96g	PNC.30.ST
	Connecting Element for PG40			PNC.40.ST
Panel Group	Connecting Element for PG30	1×HB	94g	PPC.30.ST
	Connecting Element for PG40			PPC.40.ST

HA	Fastening Set	HB	Fastening Set
	M8x25 Bolt zinc plated		M8x20 Bolt zinc plated
	M8 FlangeNut zinc plated		M8 FlangeNut M8 zinc plated
	M8x20 T Bolt nickel plated		M8x20 T Bolt nickel plated

Componentes de Puerta Batiente  
Swing Door Components

A: Cerradura para Puerta  
A: Lock for Swing Door

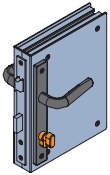

B: Bisagra para Puerta  
B: Hinge for Swing Door

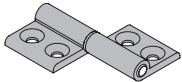

C: Tope para Puerta  
C: Buffer Block for Swing Door

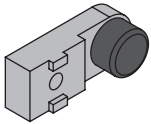

D: Componentes del Travesaño  
D: Crossbeam Components



E: Rejilla para Puerta  
E: Net Unit for Swing Door

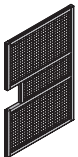

Conjunto para Panel  
Panel Group

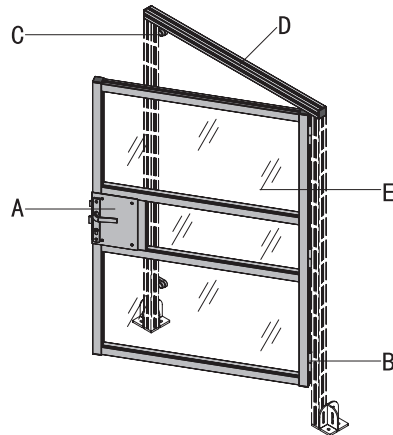

Conjunto para Malla  
Net Group

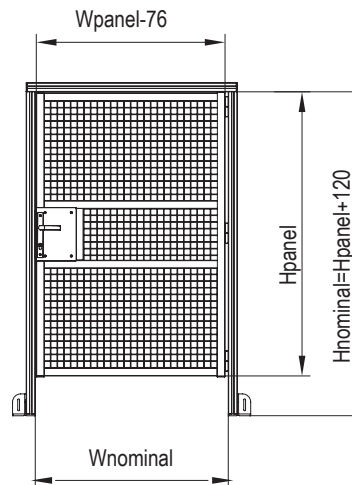
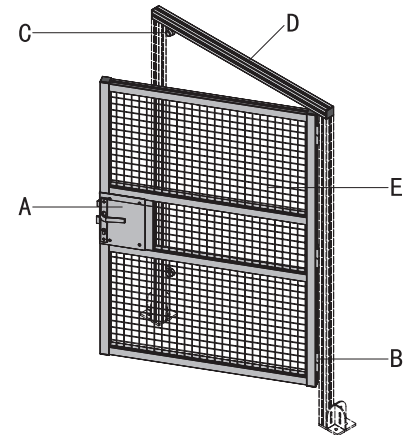

\* La Puerta Batiente no incluye los Elementos Estructurales (Postes). Se debe seleccionar perfil PG40 40x80 6 slots (ver Página 12).  
The Swing Door does not include the Strut Elements (Posts). Profile PG40 40x80 6 slots should be selected (see Page 12).

\* El perfil de travesaño PG40 40x40 4 slots está incluido en la Puerta Batiente. Se deberán usar los tornillos M14x30 para sujetar el travesaño a los postes.  
The Crossbeam profile PG40 40x40 4 slots is included in the Swing Door Unit. The M14x30 screws should be used to connect the crossbeam and the posts.

**Componentes de Puerta Corrediza**  
*Sliding Door Components*

A.B: Perfil Guía-Riel / Carro  
A.B: Profile Rails / Carriage

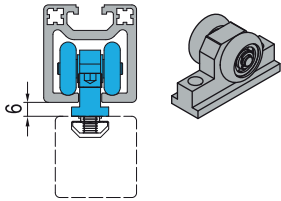

C.D: Posicionador / Tope  
C.D: Guide Block / Buffer Block

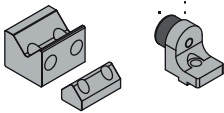

E: Cerradura para Puerta Corrediza  
E: Lock for Sliding door

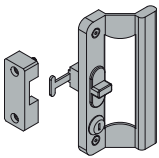

F: Rejilla para Puerta Corrediza  
F: Net Unit for Sliding Door

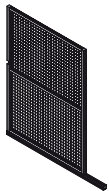

Conjunto del Panel  
Panel Group

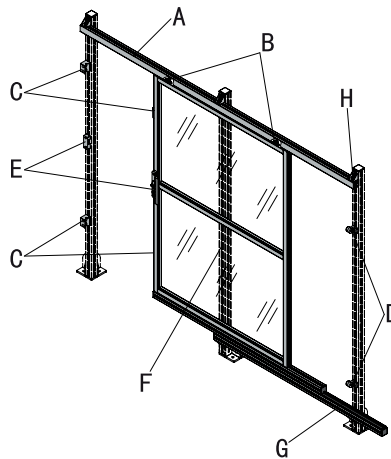

Conjunto de la Rejilla  
Net Group

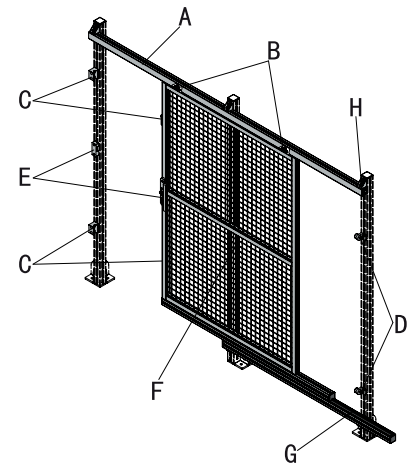

G: Guia de Fricción  
G: Friction Strip Components

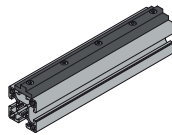

H: Escuadra  
H: Die Cast Bracket

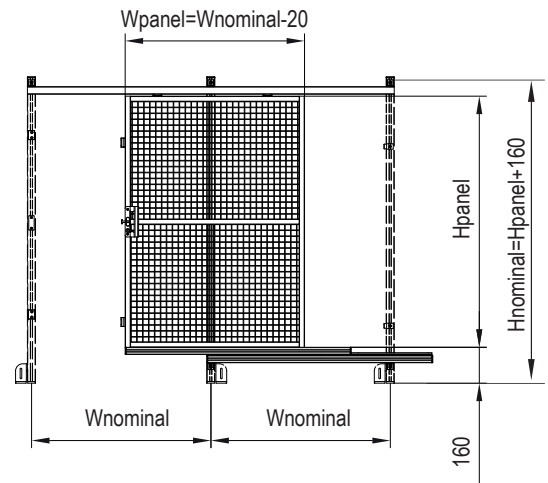
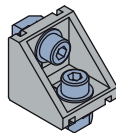

\* La Puerta Corrediza no incluye los Elementos Estructurales (Postes). Se debe seleccionar perfil PG40 40x80 6 slots for Strut Elements (ver Página 12).  
*The Swing Door does not include the Strut Elements (Posts). Profile PG40 40x80 6 slots for Strut Elements should be selected (see Page 12).*

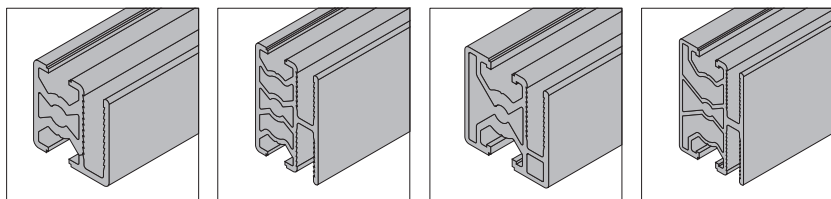
**Perfil para Malla de Protección**  
*Protective Grille Profile*

PG30 30x30 1 Grille slot

PG30 30x45 2 Grille slots

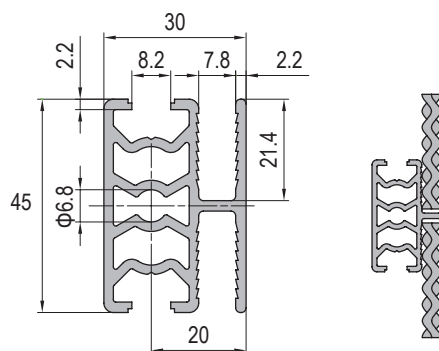
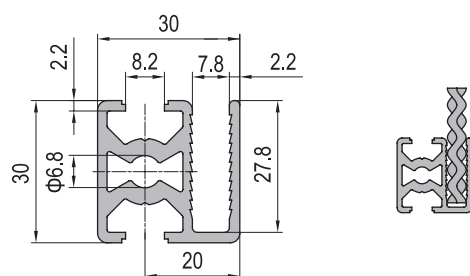

PG40 40x40 1 Grille slot

PG40 40x60 2 Grille slots

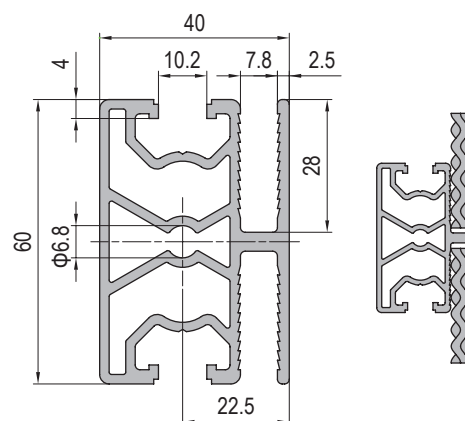
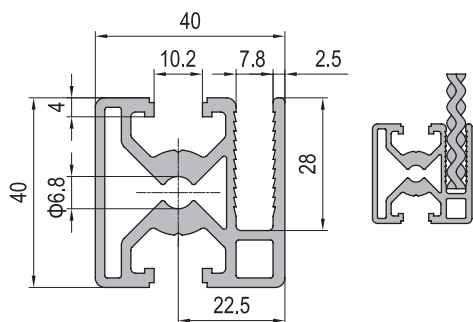

Descripción	Momento de Inercia $I_x(\text{cm}^4)$	Momento de Inercia $I_y(\text{cm}^4)$	Momento de Resistencia $W_x(\text{cm}^3)$	Momento de Resistencia $W_y(\text{cm}^3)$	Masa (kg/m)	Part No.
Protective Grille Profile PG30 30x30 1 Grille slot	3.37	2.47	2.2	1.6	0.94	1.22.30.030030.01
Protective Grille Profile PG30 30x45 2 Grille slots	7.22	4.67	4.81	2.08	1.24	1.22.30.030045.02
Protective Grille Profile PG40 40x40 1 Grille slot	9.85	8.05	4.93	4.03	1.6	1.22.40.040040.01
Protective Grille Profile PG40 40x60 2 Grille slots	23.25	13.57	11.63	4.52	2.0	1.22.40.040060.02

## Conectores para Malla de Protección

Connecting Components for Net Unit

### Tornillo Conector

Bolt Connector

Material: Acero zincado / Zinc plated steel

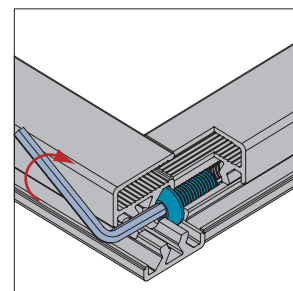
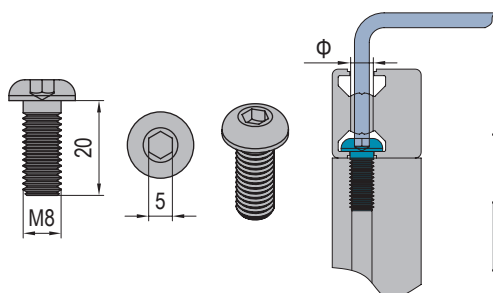

Descripción	Ø (mm)	Material	Masa (g)	Part No.
Bolt Connector	7.6	zinc plated steel	10	3.81.M8.20

### Tuerca Anti-torsión

Anti-torsion Subsequent Nut

Previene la torsión en uniones de rosca / Prevents torsion from connecting profiles with screw connector.

Material: Acero Niquelado / Nickel plated steel

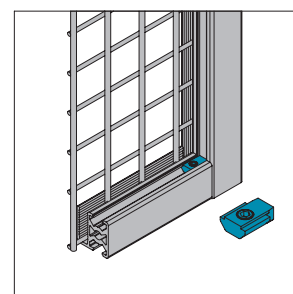
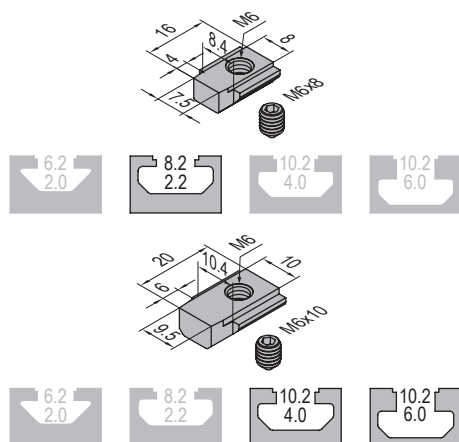

Descripción	D	Material	Masa (g)	Part No.
Anti-torsional Subsequent Nut-8 (with set screw)	M6	nickel plated steel	10	2.32.08.M6
Anti-torsional Subsequent Nut-10 (with set screw)	M6	nickel plated steel	15	2.32.10.M6

### Tapa para Perfil

End Cap for protective grille profile

Para prevenir el desgaste y mejorar la terminación. La perforación permite montar conectores con tornillos.  
 To prevent staff from any injury and improve profile end appearance. The hole enables assembly of profile and connector.

Material: ABS color negro / black

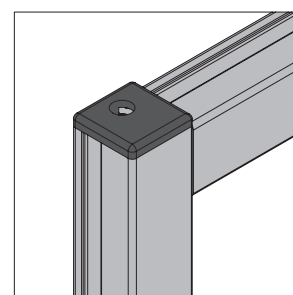
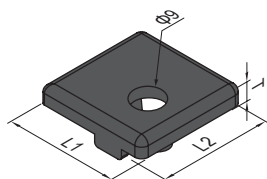

Descripción	L1 (mm)	L2 (mm)	T (mm)	Masa (g)	Part No.
Cap for Protective Grille Profile-PG30-3030	30	30	5	4	4.13.30.3030.SM
Cap for Protective Grille Profile-PG40-4040	40	40	5	6	4.13.40.4040.SM

Perfil de Sujeción para Paneles  
Clamping Profile

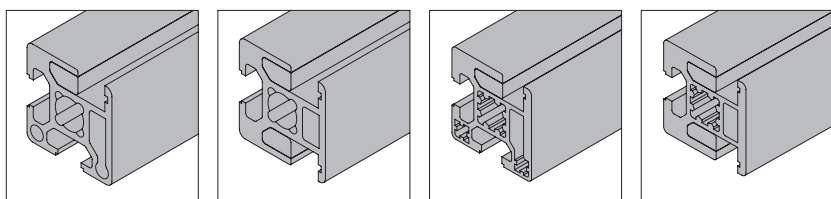

PG30 30x30 1 Clamping slot

PG30 30x30 2 Clamping slots Parallel

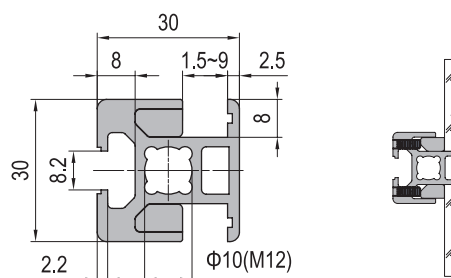
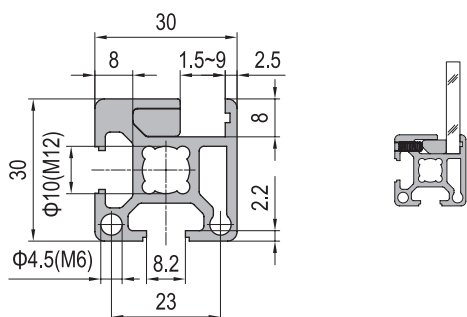

PG40 40x40 1 Clamping slot

PG40 40x40 2 Clamping slots Parallel

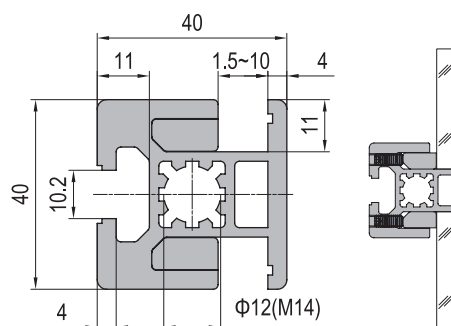
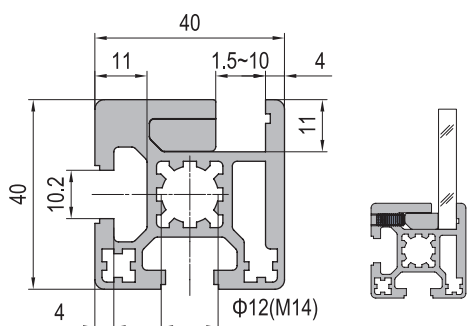

Descripción	Momento de Inercia $I_x(\text{cm}^4)$	Momento de Inercia $I_y(\text{cm}^4)$	Momento de Resistencia $W_x(\text{cm}^3)$	Momento de Resistencia $W_y(\text{cm}^3)$	Masa (kg/m)	Part No.
Clamping Profile PG30 30x30 1 Clamping slot	3.7	2.7	1.8	1.4	1.1	1.21.30.030030.01
Clamping Profile PG30 30x30 2 Clamping slots Parallel	3.5	3.3	2.2	2.2	1.3	1.21.30.030030.02P
Clamping Profile PG40 40x40 1 Clamping slot	12.3	9.5	4.4	3.4	2.2	1.21.40.040040.01
Clamping Profile PG40 40x40 2 Clamping slots Parallel	12.4	12.1	5.8	6.1	2.6	1.21.40.040040.02P

### Conectores para Paneles

Conncting Element For Panel Unit

#### Buje roscado

Bushing

Permite un montaje rápido del panel con conectores.  
 Allows quick assembly of the panel unit with connectors.

Material : Acero Zincado / Zinc plated steel

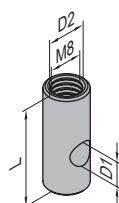
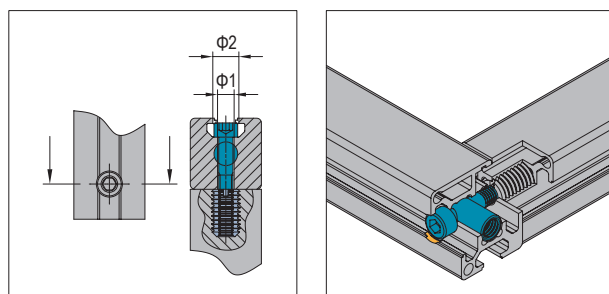

Descripción	L	D1	D2	$\phi 1$	$\phi 2$	Fastening Set	Masa (g)	Part No.
Bushing	25	6	10	7	11	M6×40	20	PPJ30.ST
Bushing	30	8	12	9	14	M8×40	40	PPJ40.ST

#### Tornillo reductor

Hole Reducer Bolt

Para reducir el diámetro de la rosca.  
 To reduce the diameter of the existing hole to fit any desired screw size.

Material: Acero niquelado / Nickel plated steel

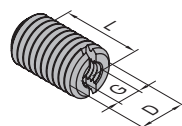
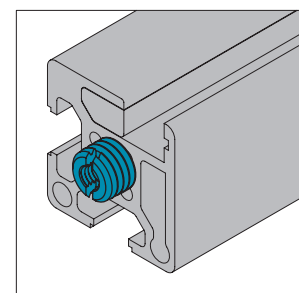

Descripción	D	G	L	Masa (g)	Part No.
Hole Reducer Bolt-M12/M6	M12	M6	20	11	2.51.12.06
Hole Reducer Bolt-M14/M8	M14	M8	20	14	2.51.14.08

#### Tapa para Perfil de Sujeción

End Cap for clamping profile

Para prevenir el desgaste y mejorar la terminación. La perforación permite montar conectores con tornillos.  
 To prevent staff from any injury and improve profile end appearance. The hole enables assembly of profile and connector.

Material: ABS color negro / black

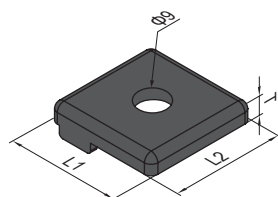
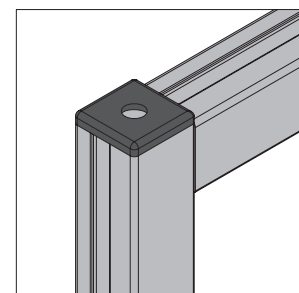

Descripción	L1 (mm)	L2 (mm)	T (mm)	Masa (g)	Part No.
	30	30	5	4	4.12.30.3030.SM
End Cap for Clamping Profile PG40-4040	40	40	5	6	4.12.40.4040.SM



**Perfil de Aluminio**  
*Strut Profile*

PG40 40x40 4 slots

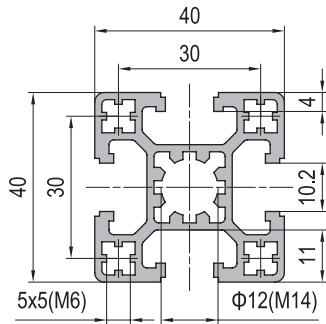

PG40 40x80 6 slots

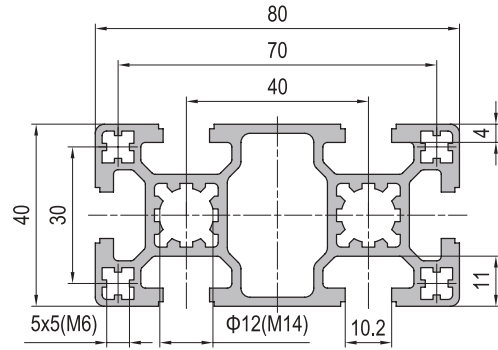

\* Perfil a ser usado como componente de travesaño para Puerta Batiente.  
*Profile to be used as a Crossbeam Component for Swing Door.*

\* Perfil a ser usado como Elemento Estructural para Puerta Batiente.  
*Profile to be used as a Strut Element for Swing Door.*

PG40 40x80 6 slots For Strut Elements

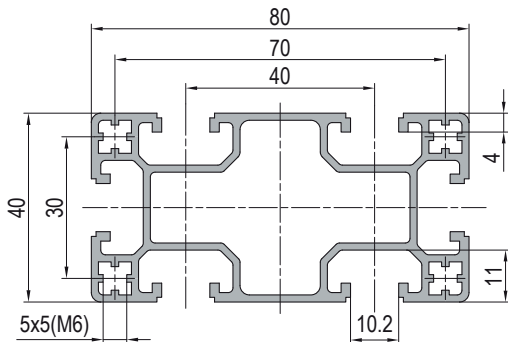

PG40 40x80 6 slots Heavy

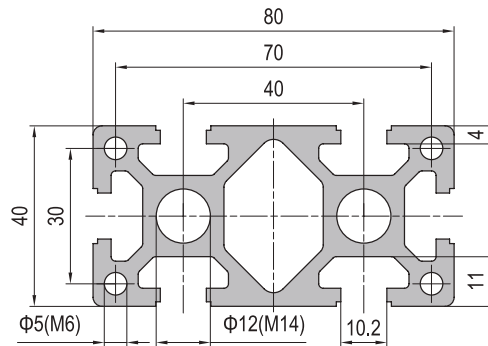

\* Perfil a ser usado como Elemento Estructural para Paneles  $H \leq 2200$ mm.  
*Profile to be used as Strut Profile for Panels with  $H \leq 2200$ mm.*

\* Perfil a ser usado como Elemento Estructural para Paneles  $2200 < H \leq 3600$ mm.  
*Profile to be used as Strut Profile for Panels with  $2200 < H \leq 3600$ mm.*

\* Perfil a ser usado como Elemento Estructural para Puerta Corridiza.  
*Profile to be used as Strut Profile for Sliding Door.*

Descripción	Momento de Inercia $I_x(\text{cm}^4)$	Momento de Inercia $I_y(\text{cm}^4)$	Momento de Resistencia $W_x(\text{cm}^3)$	Momento de Resistencia $W_y(\text{cm}^3)$	Masa (kg/m)	Part No.
Strut Profile PG40 40x40 4 slots	9.1	9.1	4.6	4.6	1.6	1.11.40.040040.04
Strut Profile PG40 40x80 6 slots for Strut Elements	16.6	59.1	7.9	14.8	2.5	1.42.40.040080.06.SE
Strut Profile PG40 40x80 6 slots	11.6	63.2	8.3	15.8	2.7	1.11.40.040080.06
Strut Profile PG40 40x80 6 slots Heavy	22.2	80.8	11.1	20.2	3.6	1.11.40.040080.06H

**Platina de Anclaje**  
Base Plate

La Platina de Anclaje permite fijar los Elementos Estructurales (Postes) al suelo mediante la utilización de tacos de expansión.  
Base Plate is used to anchor the Strut Elements (Posts) to the floor using expansion bolts.

Material y Color: Acero al carbono con tratamiento de electroforesis color negro  
Mild Steel with black electrophoresis treatment

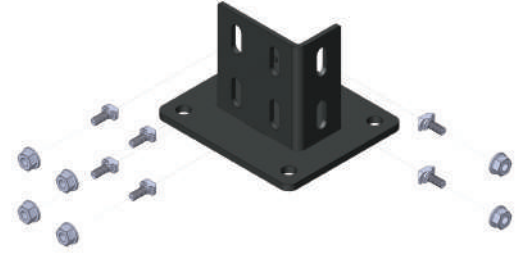

**Platina de Anclaje 40x80**  
Base Plate 40x80

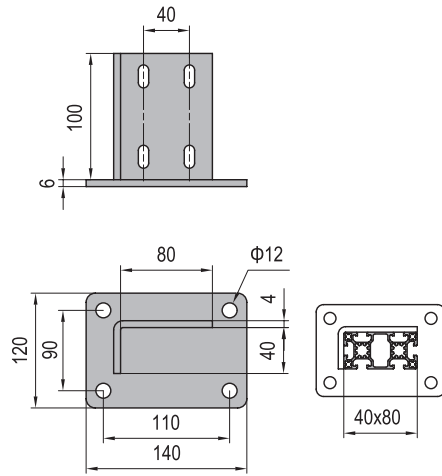

C	Fastening Set	AA	Fastening Set
	M8 Flange Nut zinc plated		M8x100 expansion bolt zinc plated
	M8x20 T Bolt nickel plated		

Descripción	L (mm)	W (mm)	A (mm)	B (mm)	C (mm)	D (mm)	Fastening Set	Masa (g)	Part No.
Custom Base Plate-Type L-4080 (set)	140	120	90	110	40	80	4xC	1475	5.13.4080.ST.SM

\* La Platina de Anclaje de los Elementos Estructurales (Postes) no incluye tacos de expansión.  
The Strut Profile Base Plate does not include the expansion bolts.

## Accesorios del Perfil

### Profile Accessories

#### Tapa

##### End Cap

Para prevenir el desgaste, ocultar extremos filosos y mejorar la terminación.

*End Cap prevents staff from any injury and improve profile end appearance.*

Material y color: ABS negro / black

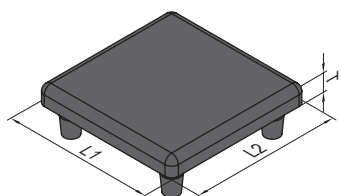
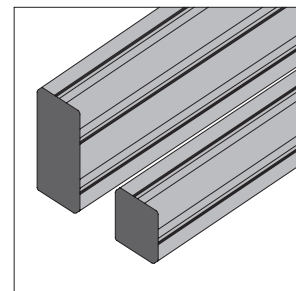

Tipo B  
Type B

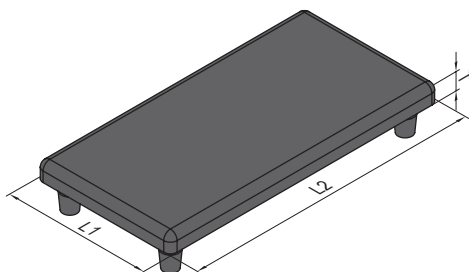

Tipo C  
Type C

Descripción		L1 (mm)	L2 (mm)	T (mm)	Masa (g)	Part No.
Type B	End Cap-PG40-4040	40	40	5	6	4.11.40.4040
	End Cap-PG40-8080	80	80	5	22	4.11.40.8080
	End Cap-PG45-4545	45	45	5	8	4.11.45.4545
	End Cap-PG45-9090	90	90	5	28	4.11.45.9090
	End Cap-PG60-6060	60	60	5	14	4.11.60.6060
Type C	End Cap-PG40-4080	40	80	5	13	4.11.40.4080
	End Cap-PG45-4560	45	60	5	11	4.11.45.4560
	End Cap-PG45-4590	45	90	5	16	4.11.45.4590

**Bisagra para puertas**  
Hinge for Swing Door

Material y Color: Aluminio anodizado gris / Anodized aluminium grey

**Bisagra de Puerta-Izquierda-A**  
Door Hinge-Left-A

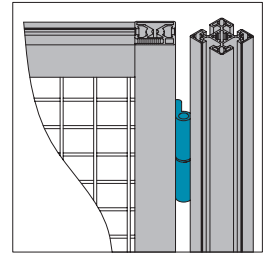
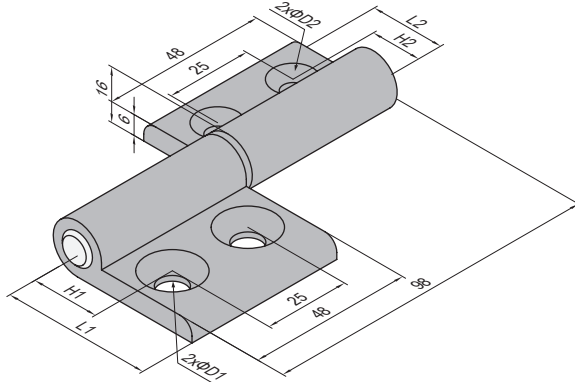
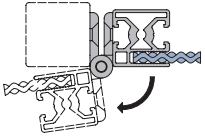

**Bisagra de Puerta-Derecha-B**  
Door Hinge-Right-B

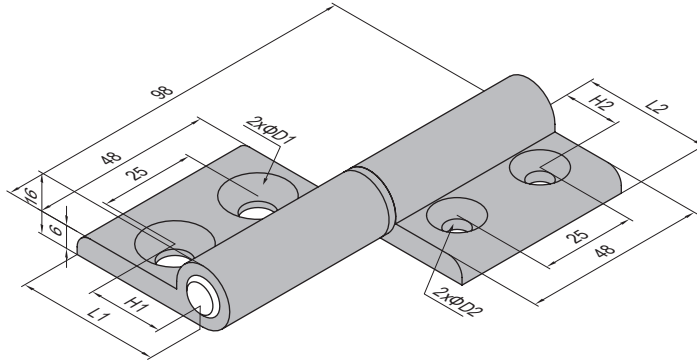
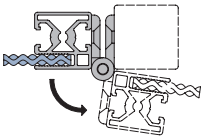

FF	Fastening Set	FG	Fastening Set
	M6x12 Bolt zinc plated		M8x16 Bolt zinc plated
	M6 T Nut nickel plated		M8 T Nut nickel plated

Descripción		H1 (mm)	H2 (mm)	L1 (mm)	L2 (mm)	D1 (mm)	D2 (mm)	Fastening Set	Masa (g)	Part No.
Net Group	30/40-A (set)	20	20	28	38	6.5	8.5	2xFF+2xFG	162	7.27.30.40.ST.SM
	30/40-B (set)									7.26.30.40.ST.SM
	40/45-A (set)	22.5	22.5	38	38	8.5	8.5	4xFG	186	7.27.45.45.ST
	40/45-B (set)									7.26.45.45.ST
Panel Group	30/40-A (set)	20	15	38	28	8.5	6.5	2xFF+2xFG	158	7.27.30.40.ST
	30/40-B (set)									7.26.30.40.ST
	40/45-A (set)	22.5	20	38	38	8.5	8.5	4xFG	186	7.27.40.45.ST
	40/45-B (set)									7.26.40.45.ST

**Cerradura para Puertas Batientes**  
Lock for Swing Door

**Cuerpo de Cerradura**  
Lock Body

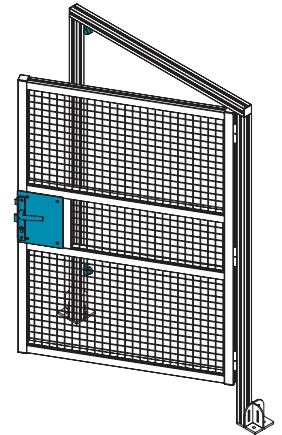
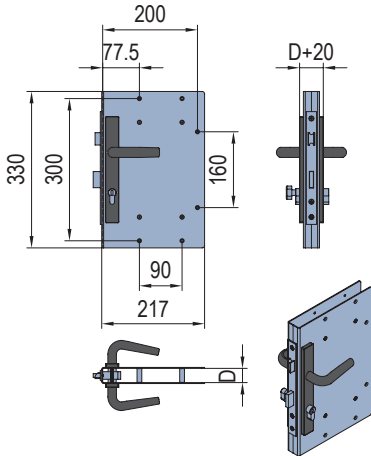

**Ranura de Cerradura**  
Lock Slot

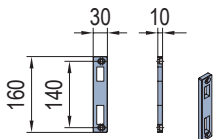

	Descripción	D (mm)	L (mm)	Masa (g)	Part No.
Net Group	Lock for Swing Door PG30	30	255	4100	PNDH30.LK
	Lock for Swing Door PG40	40	265	4800	PNDH40.LK
Panel Group	Lock for Swing Door PG30	30	255	4100	PPDH30.LK
	Lock for Swing Door PG40	40	265	4800	PPDH40.LK

**Tope para Puertas Batientes**  
Buffer Block for Swing Door

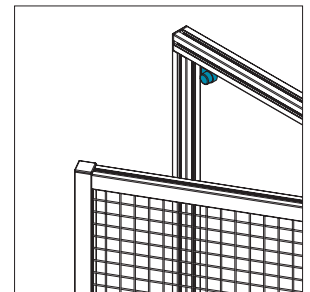
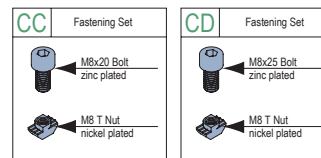
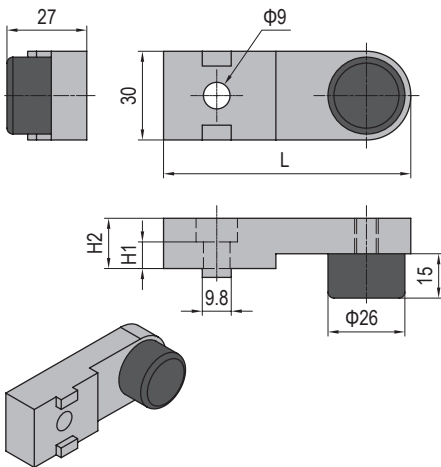

	Descripción	H1 (mm)	H2 (mm)	L (mm)	Fastening Set	Masa (g)	Part No.
Net Group	Buffer Block for Swing Door PG30	9	17	88	1xCC	112	PNDH30.BB
	Buffer Block for Swing Door PG40	14	22	88	1xCD	121	PNDH40.BB
Panel Group	Buffer Block for Swing Door PG30	9	17	88	1xCC	112	PPDH30.BB
	Buffer Block for Swing Door PG40	14	22	88	1xCD	121	PPDH40.BB

**Cerradura para Puertas Corredizas**  
Lock for Swing Door

**Cuerpo de Cerradura**  
Lock Body

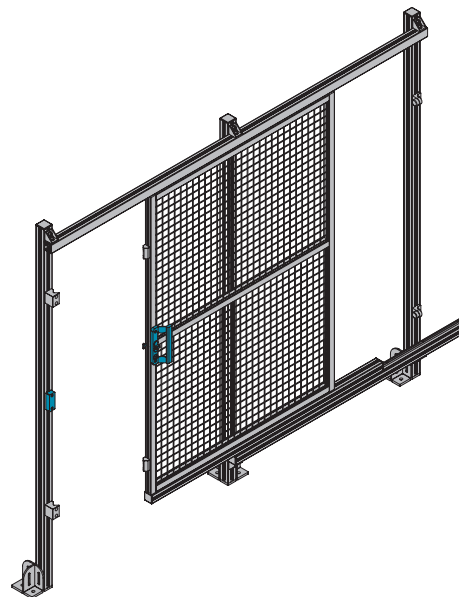
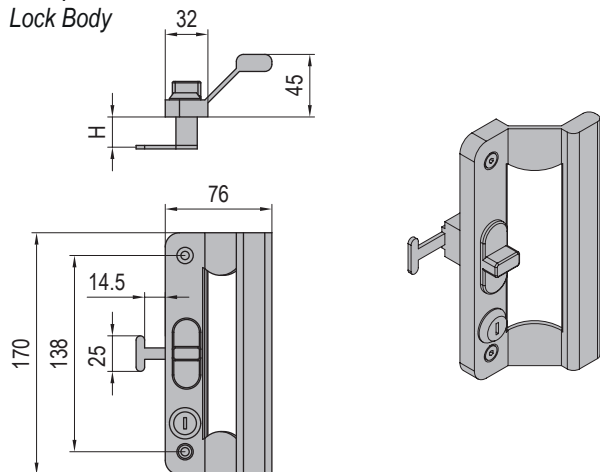

**Ranura de Cerradura**  
Lock Slot

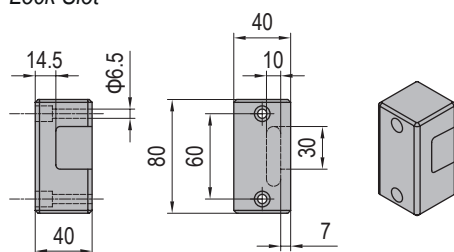

Descripción		H (mm)	Fastening Set	Masa (g)	Part No.
Net Group	Lock for Sliding Door-30	18	2xHG	910	PNDS30.LK
	Lock for Sliding Door-40	20	2xHG	910	PNDS40.LK
Panel Group	Lock for Sliding Door-30	12	2xHG	910	PPDS30.LK
	Lock for Sliding Door-40	18	2xHG	910	PPDS40.LK

HG	Fastening Set
	M6x40 Bolt zinc plated
	M6x20 Bolt zinc plated
	M6 T Nut nickel plated

Posicionador para Puerta Corrediza  
Guide Block for Sliding Door

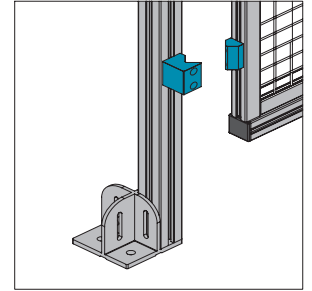
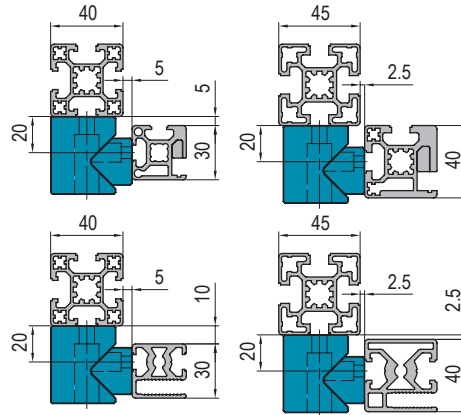
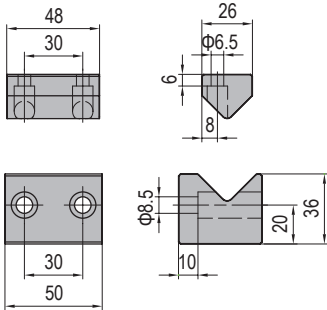

HD	Fastening Set	HE	Fastening Set	HF	Fastening Set
	M8x20 Bolt zinc plated		M6x12 Bolt zinc plated		M6x16 Bolt zinc plated
	M8 T Nut nickel plated		M6 T Nut nickel plated		M6 T Nut nickel plated

Descripción	Fastening Set	Masa (g)	Part No.
Door Shutter for PG30	2xHD+2xHE	151	PBDS30.DS
Door Shutter for PG40	2xHD+2xHF	157	PBDS40.DS

Perfil Guía / Riel  
Profile Rail

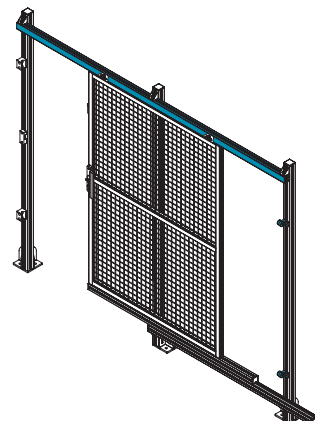
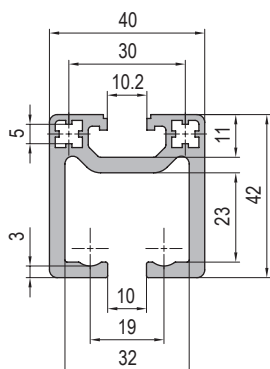

Descripción	Momento de Inercia Ix(cm <sup>4</sup> )	Momento de Inercia Iy(cm <sup>4</sup> )	Módulo Resistente Wx(cm <sup>3</sup> )	Módulo Resistente Wy(cm <sup>3</sup> )	Masa (kg/m)	Part No.
Profile Rail	12.7	10.6	6.4	5.1	1.6	1.42.40.4040.01

Carro para Puerta Corrediza  
Pulley Block for Sliding Door

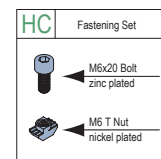
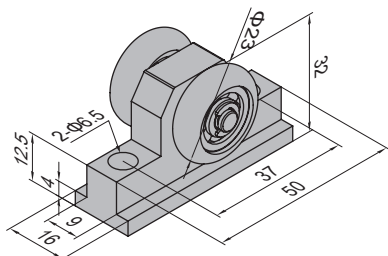

Descripción	Fastening Set	Masa (g)	Part No.
Pulley Block for PG30	2xHC	64	PBDS30.PB
Pulley Block for PG40	2xHC	70	PBDS40.PB

Tope para Puerta Corrediza  
Buffer Block for Sliding Door

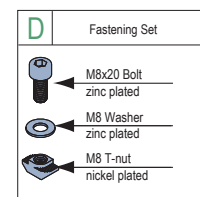
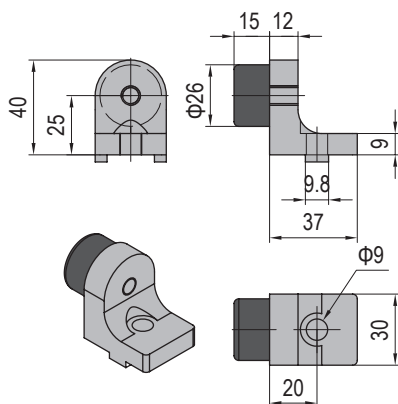

Descripción	Fastening Set	Masa (g)	Part No.
Buffer Block for Sliding Door	1xD	64	PBDS30.BB



**Componentes de la Guía de Fricción**  
*Friction Strip Components*

Se coloca en la parte inferior de la puerta corrediza, sobre el perfil guía, para mejorar la resistencia al desgaste y guiar la puerta desde el lado inferior.  
*The Friction Strip is installed on top of the Profile Rail. It enables economical and low wear guide for Sliding Doors.*

Material: UHMW PE

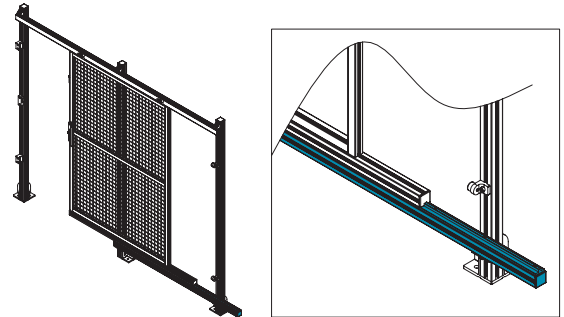
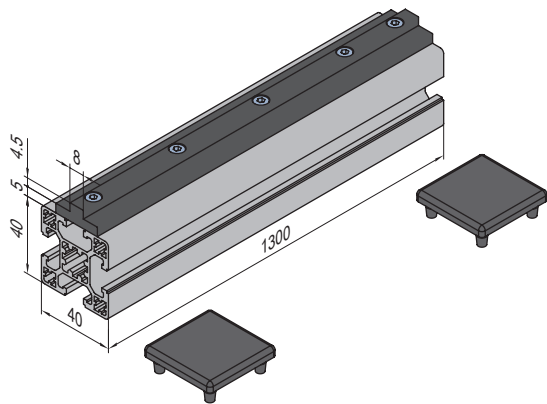

Descripción	Masa (g)	Part No.
Friction Strip Components	11	PPDS.FS.ST

**Escuadra**  
*Die Cast Bracket*

Material: Fundición de Aluminio / *Die Cast Aluminium*

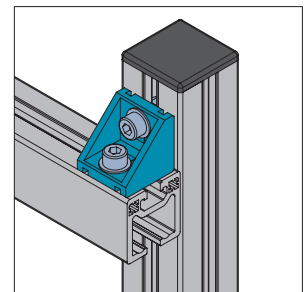
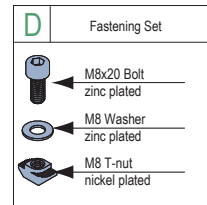
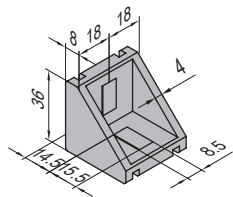

Descripción	Fastening Set	Masa (g)	Part No.
Die cast bracket	2xD	11	3.21.40.4040.STD



Sistema de Ensamble Modular  
*Modular Assembly System*

MAS



Sistema de Transportadores Modulares  
*Modular Conveyor System*

MCS



Sistema de Plataformas y Escaleras  
*Stair and Platform System*

SPS



Sistema de Cerramientos de Seguridad  
*Machine Guard System*

MGS



Sistema de Estructuras Tubulares  
*Tubular Framing System*

TFS



Alutipo SRL  
Web: [www.alutipo.com](http://www.alutipo.com)  
Email: [info@alutipo.com](mailto:info@alutipo.com)

# Machine Guard System