



ECUGUARD

alutipo  
BUSINESS PARTNER



**Sistema de Cerramientos de Seguridad**  
*Safety Fencing System*



Sistema de Cerramientos de Seguridad  
*Safety Fencing System*

## Sistema de Cerramientos de Seguridad Safety Fencing System

Ecoguard se especializa en el desarrollo y fabricación de cerramientos de seguridad de acero para aplicaciones en automatización industrial y logística de almacenamiento.

Los productos Ecoguard se fabrican siguiendo lineamientos de diseño rigurosos, de tecnología avanzada, y confiables en conformidad con las normativas ISO, normativas GB, y la Directiva Europea sobre Maquinaria. Esto proporciona una solución rápida, eficiente, y segura para la protección de máquinas.

*Ecoguard is specialized in developing and manufacturing steel safety fencing systems for industrial automation and warehousing logistics applications.*

*Ecoguard products are manufactured following rigorous, advanced technology and reliable design guidelines in accordance with ISO standards, GB standards, and the European Machinery Directive. This provides fast, efficient, and safe solution for machine protection.*

## Certificaciones Qualifications

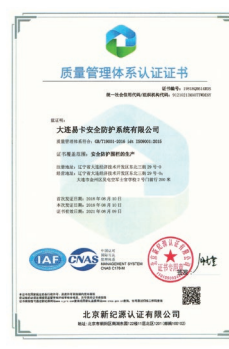
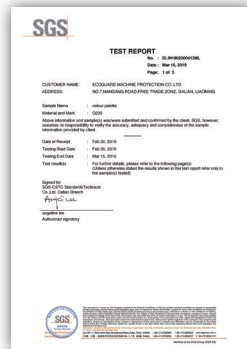
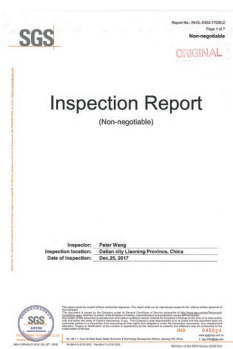
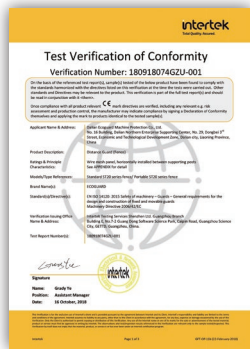

Passed Intertek professional test, CE certified



2006/ 42/ EC  
12100  
14120  
13857



The standard panel has been certified by SGS test.  
The mesh panels can withstand the maximum impact of 1600 joules.  
The Salt Spray test (NSS) has reached more than 300 hours and the appearance rate is 10.  
The safety distance of the machine guard is 120mm.





ST20 Panel de Chapa  
ST20 Steel Panel

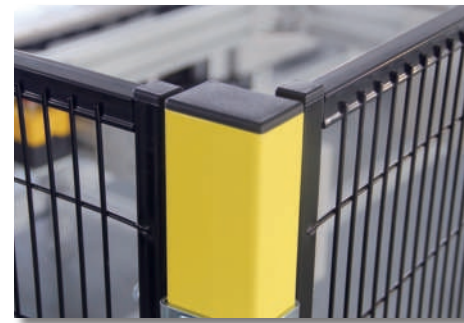

Poste Serie 40  
40 Series Post

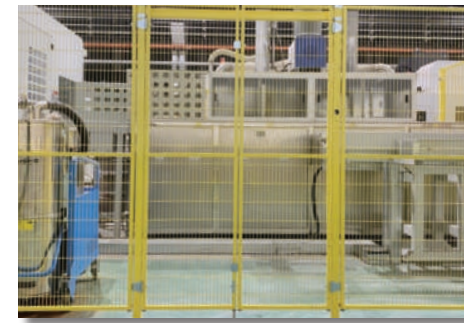

Puerta Batiente  
Hinged Door



Bandeja para Cableado  
Wire Tray



Accesorio de Panel  
Panel Accessory

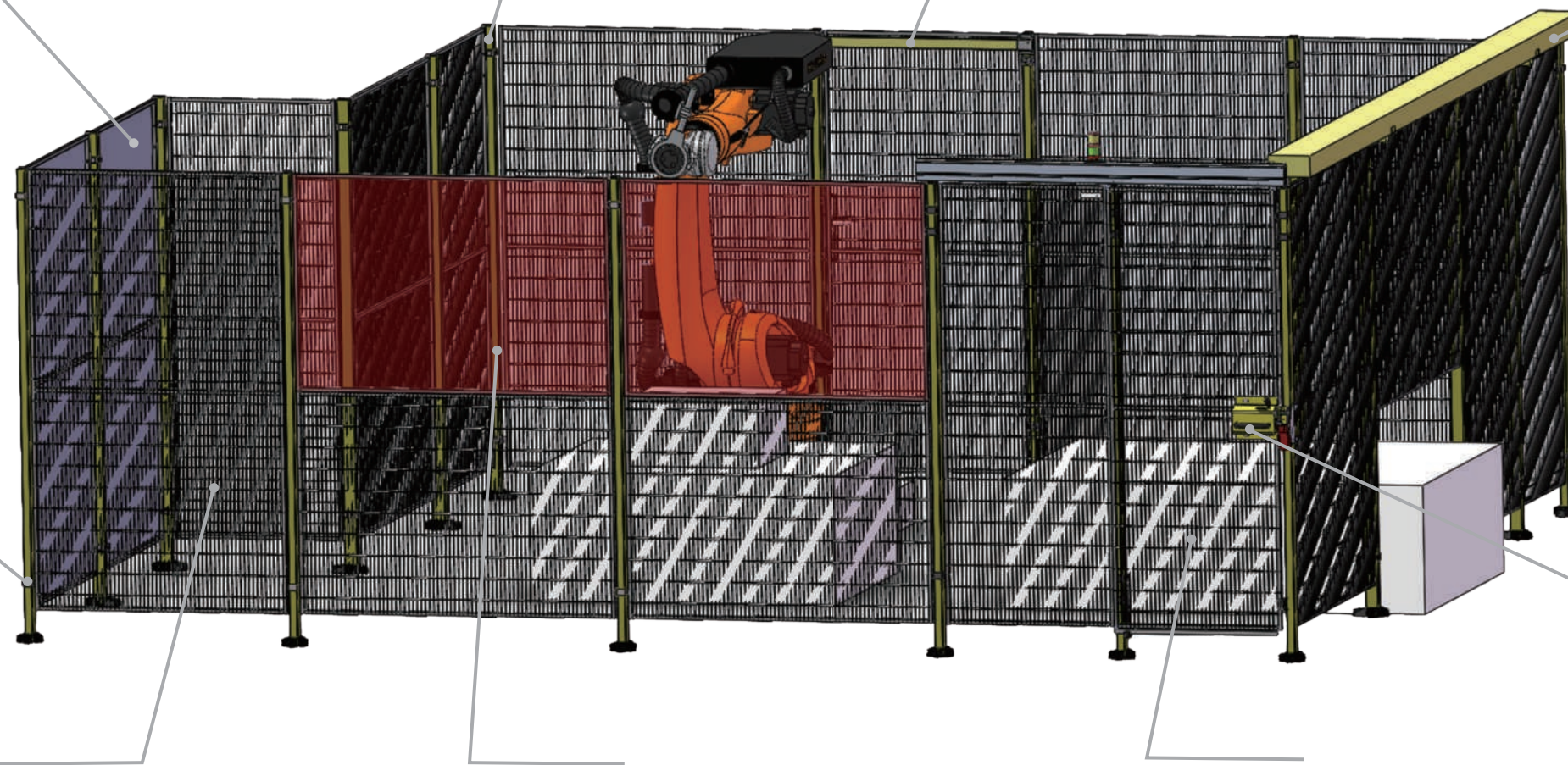

Cerradura de Seguridad  
Safe Lock



ST20 Panel de Malla  
ST20 Mesh Panel



ST20 Panel de PC (Policarbonato)  
ST20 PC Panel



Puerta Deslizante  
Sliding Door



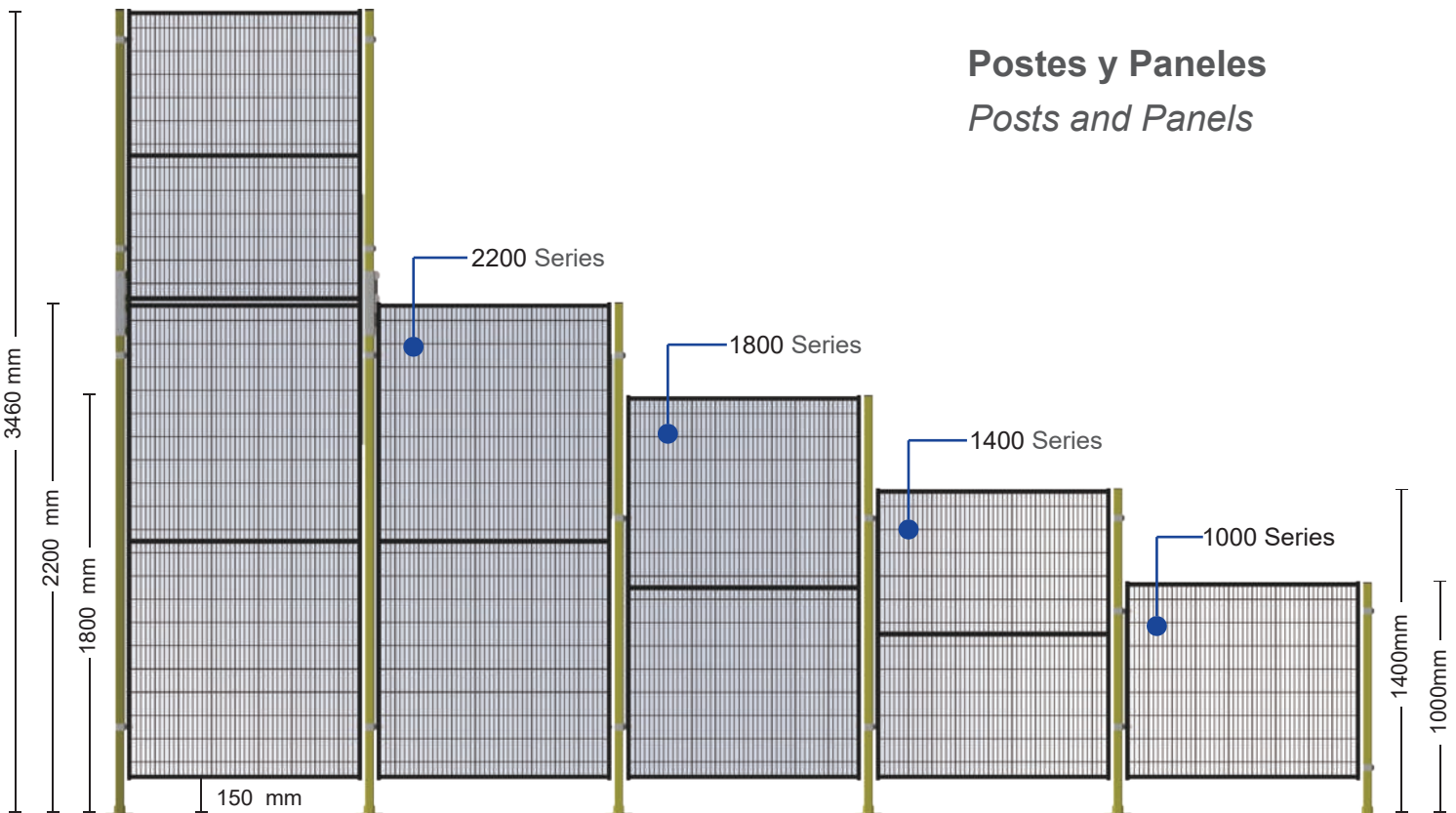

## Postes y Paneles *Posts and Panels*

## Poste Serie 40 Post 40 Series

Perfil de sección cuadrada: 40x60mm

Base: 160x120mm

Color estándar: Amarillo (RAL1018)

Accesorios incluidos en el set:

- Tacos de anclaje M10\*80 (x3)
- Conector de fijación-Poste Serie 40 (x2)
- Tapa de extremo 4060 (x1)
- Tapa de extremo 2020-ST20 Panel de Malla (x4)

Otros accesorios no incluidos:

- Cubierta de pie-Serie 40 (x1)
- Código de Producto 13 400 013

Square Tube: 40x60mm

Base: 160x120mm

Standard Color: Yellow (RAL1018)

Accessories included as part of the set:

- M10\*80 Expansion Bolt (x3)
- Fixing Connector-40 Series Post (x2)
- End Cap 4060 (x1)
- End Cap 2020-ST20 Mesh Panel (x4)

Other accessories not included:

- 40 Series Foot Cover (x1)
- Product Code 13 400 013

### Color selection



RAL 1018



RAL 9005



RAL 7037



RAL 9016



RAL 3020



RAL 5005

Altura / Height H	Código de Producto / Product code (pcs)	Código de Producto / Product code (set)	Peso / Weight (kg)
1000	13 403 100	05 000 067	2.8
1400	13 403 200	05 000 066	3.6
1800	13 403 300	05 000 065	4.5
2200	13 403 400	05 000 064	5.4

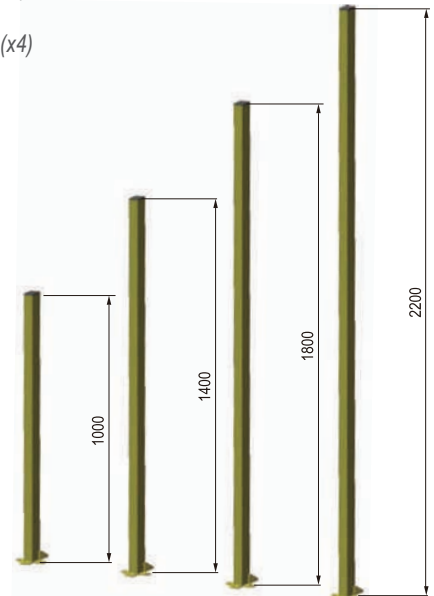

## Poste Serie 80 Post 80 Series

Perfil de sección cuadrada: 80x80mm

Base: 200x200mm

Color estándar: Amarillo (RAL1018)

Otros accesorios no incluidos:

- Tacos de anclaje M10\*80 (x4)
- Conector de fijación-Poste Serie 80 (x2)
- Tapa de extremo 8080 (x1)

Square Tube: 80x80mm

Base: 200x200mm

Standard Color: Yellow (RAL1018)

Other accessories not included:

- M10\*80 Expansion Bolt (x4)
- Fixing Connector-80 Series Post (x2)
- End Cap 8080 (x1)

### Color selection



RAL 1018



RAL 9005



RAL 7037



RAL 9016



RAL 3020



RAL 5005

Altura / Height H	Código de Producto / Product code (pcs)	Peso / Weight (kg)
1400	13 404 200	14.1
1800	13 404 300	17.0
2200	13 404 400	19.9

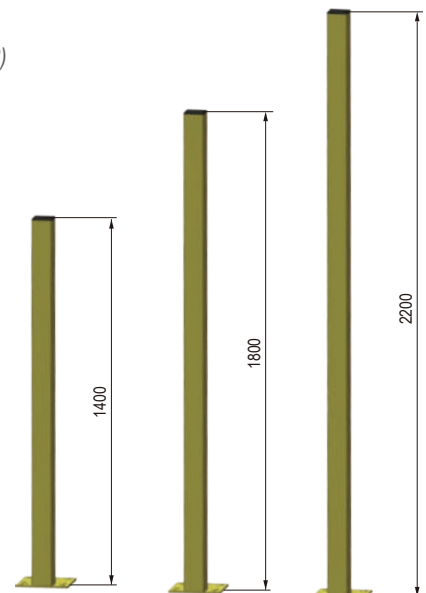

## ST20 Panel de Malla ST20 Mesh Panel

Separación de Malla: 20x100mm  
 Diámetro de alambre: 3mm  
 Perfil sección cuadrada (marco): 20x20mm  
 Agujero de conexión: 10mm  
 Color estándar: Negro (RAL9005)

Accesorios no incluidos:

- Tapa de extremo 2020-ST20 Panel de Malla (x4)

*Steel Wire Spacing: 20x100mm*  
*Steel Wire Diameter: 3mm*  
*Frame Square Tube: 20x20mm*  
*Connection Hole: 10mm*  
*Standard Color: Black (RAL9005)*

Accessories not included:

- End Cap 2020-ST20 Mesh Panel (x4)

### Color selection



RAL 1018



RAL 9005



RAL 7037



RAL 9016



RAL 3020



RAL 5005

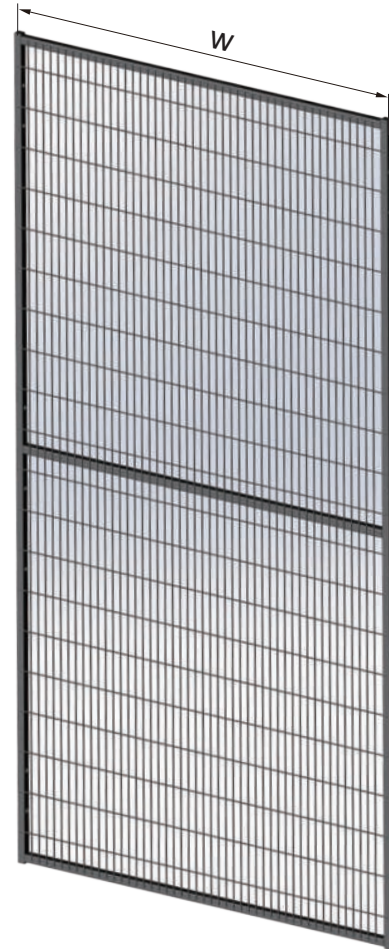

Serie Series	Ancho W Width W	Código de Producto Product code	Peso(kg) Weight(kg)	Serie Series	Ancho W Width W	Código de Producto Product code	Peso(kg) Weight(kg)
1000	200	13 111 102	1.6	1800	200	13 111 302	3.0
	300	13 111 103	2.0		300	13 111 303	3.8
	500	13 111 105	2.8		500	13 111 305	5.2
	700	13 111 107	3.6		700	13 111 307	6.6
	800	13 111 108	4.0		800	13 111 308	7.3
	1000	13 111 110	4.8		1000	13 111 310	8.8
	1200	13 111 112	5.5		1200	13 111 312	10.2
	1500	13 111 115	6.7		1500	13 111 315	12.3
1400	200	13 111 202	2.4	2200	200	13 111 402	4.1
	300	13 111 203	3.0		300	13 111 403	4.5
	500	13 111 205	4.1		500	13 111 405	6.2
	700	13 111 207	5.3		700	13 111 407	7.9
	800	13 111 208	5.9		800	13 111 408	8.8
	1000	13 111 210	7.0		1000	13 111 410	10.5
	1200	13 111 212	8.2		1200	13 111 412	12.2
	1500	13 111 215	9.9		1500	13 111 415	14.7

- El código de producto es específico de la pieza, no incluye accesorios.  
The product code is for one single piece, excluding any accessories.





## Puertas *Doors*

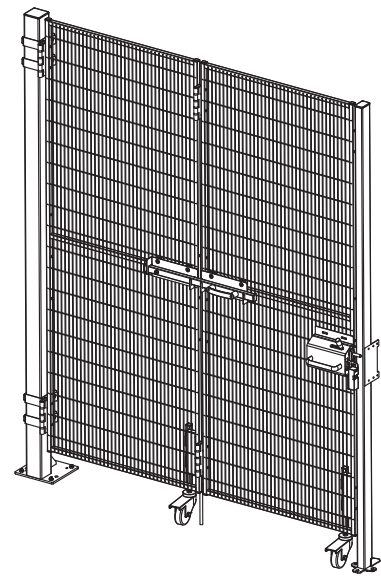
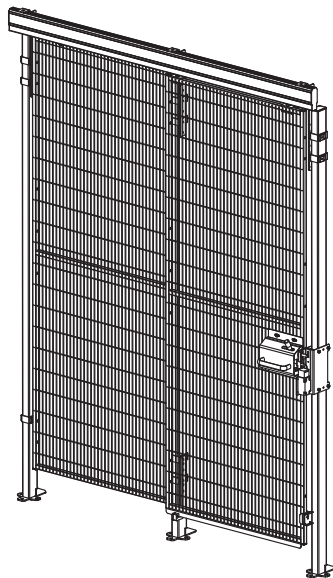
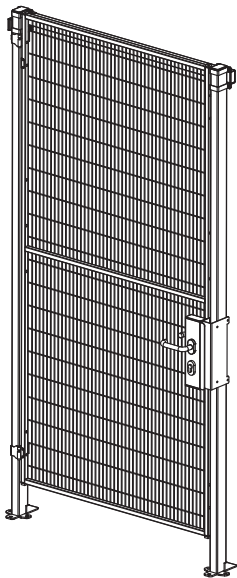



## Puerta Batiente Simple Single Hinged Door

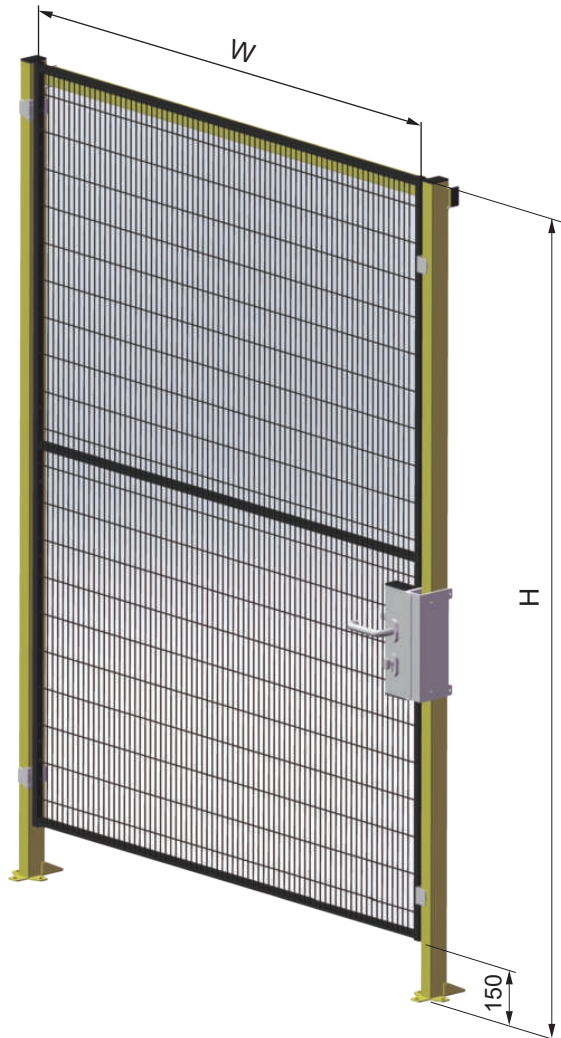

■ Imagen muestra Puerta-Apertura Izq (LHS)

Ángulo de apertura máx=160°

Accesorios incluidos en el set:

- Panel de Puerta-ST20 (x1)
- Bisagras de Puerta (x2)
- Viga de Puerta (x1)
- Tope y accesorios relacionados

Accesorios no incluidos:

- Cerradura (x1)
- Interruptor Enclavamiento Seguridad (x1)

■ Image displays Door-Left Open (LHS)

Opening angle=160°

Standard accessories included:

- Door Panel-ST20 (x1)
- Door Hinges (x2)
- Door Beam (x1)
- Door Stop and related accessories

Accessories not included:

- Lock (x1)
- Electronic Safety Switch (x1)

### Tipos de Cerradura Aplicables Applicable Lock Types



Cerradura Magnética  
LHS & RHS: 13 331 120



Cerradura de Llave  
LHS: 13 311 100  
RHS: 13 311 200

Magnetic Door Handle  
LHS & RHS: 13 331 120

Key Lock  
LHS: 13 311 100  
RHS: 13 311 200



Cerradura de Seguridad  
LHS: 13 322 100  
RHS: 13 322 200

Safety Lock General Type  
LHS: 13 322 100  
RHS: 13 322 200

Altura H Height H	Ancho W Width W	Código L Product code L	Código R Product code R	Peso (kg) Weight (kg)
1400	700	13 211 110	13 212 110	7.5
	800	13 211 120	13 212 120	8.3
	1000	13 211 130	13 212 130	9.7
	1200	13 211 140	13 212 140	11.3
	1500	13 211 150	13 212 150	13.5
1800	700	13 211 210	13 212 210	8.8
	800	13 211 220	13 212 220	9.7
	1000	13 211 230	13 212 230	11.5
	1200	13 211 240	13 212 240	13.3
	1500	13 211 250	13 212 250	15.9
2200	700	13 211 310	13 212 310	10.1
	800	13 211 320	13 212 320	11.2
	1000	13 211 330	13 212 330	13.2
	1200	13 211 340	13 212 340	15.3
	1500	13 211 350	13 212 350	18.3

## Puerta Batiente Doble Double Hinged Door

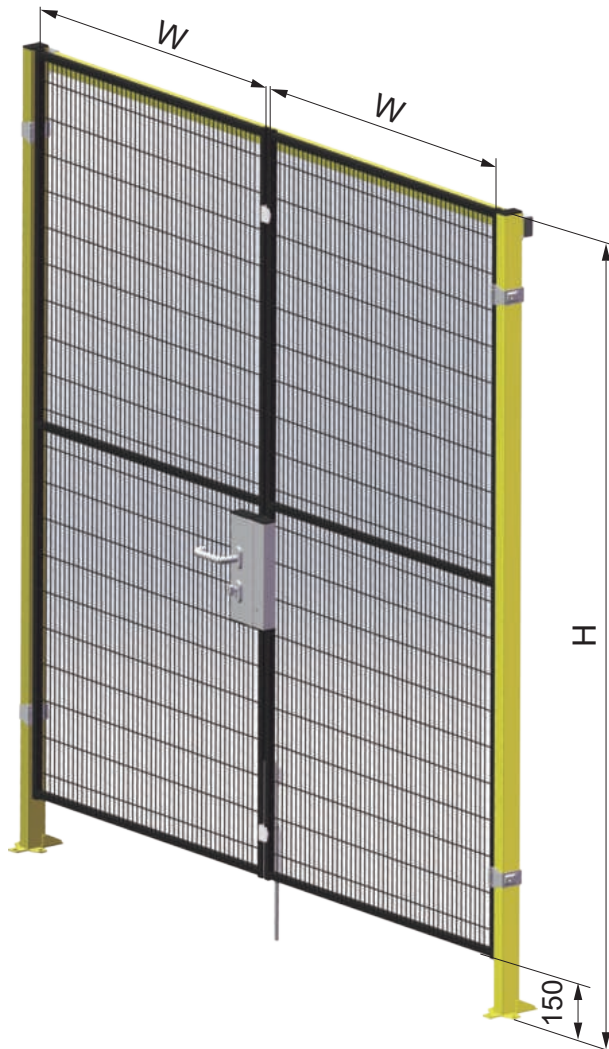

- Imagen muestra Puerta-Apertura Izq (LHS)  
 Ángulo de apertura máx=160°  
 Accesorios incluidos en el set:
  - Panel de Puerta-ST20 (x2)
  - Viga de Puerta (x1)
  - Bisagras de Puerta (x4)
  - Tope y accesorios relacionados
  - Pasador a Piso (x1)
- Accesorios no incluidos:
  - Poste Serie 40-Set (x2)
  - Cerradura (x1)

- Image displays Door-Left Open (LHS)  
 Opening angle=160°  
 Standard accessories included:
  - Door Panel-ST20 (x1)
  - Door Beam (x1)
  - Door Hinges (x2)
  - Door Stop and related accessories
  - Ground Latch (x1)
- Accessories not included:
  - 40 Series Post-Set (x2)
  - Lock (x1)

### Tipos de Cerradura Aplicables Applicable Lock Types



Cerradura de Llave  
 Double: 13 311 300

Key Lock  
 Double: 13 311 300



Cerradura de Seguridad  
 Double: 13 321 300

Safety Lock General Type  
 Double: 13 321 300

Altura H Height H	Ancho W Width W	Código de Producto Product code	Peso (kg) Weight (kg)
1400	700	13 221 110	15.1
	800	13 221 120	16.6
	1000	13 221 130	19.5
	1200	13 221 140	22.7
	1500	13 221 150	27.1
1800	700	13 221 210	17.7
	800	13 221 220	19.4
	1000	13 221 230	23.1
	1200	13 221 240	26.7
2200	1500	13 221 250	31.9
	700	13 221 310	20.3
	800	13 221 320	22.4
	1000	13 221 330	26.5
	1200	13 221 340	30.7
	1500	13 221 350	36.7



## Puerta Corrediza Simple Single Sliding Door

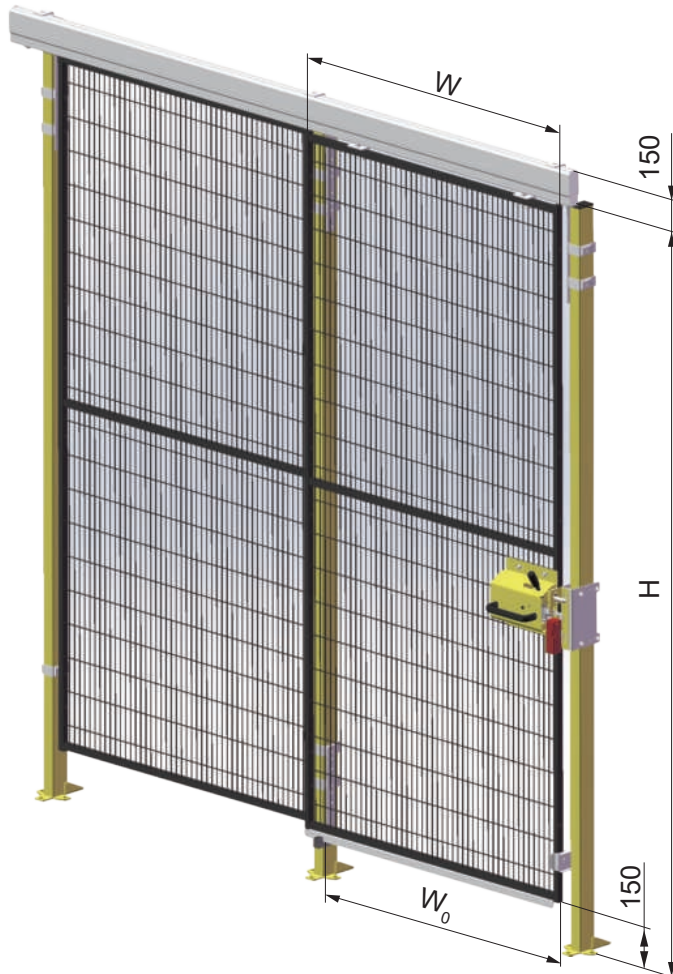

- Imagen muestra Puerta-Apertura Izq (LHS)  
 Ancho de apertura  $W_0$  = Ancho de panel  $W$  - 100mm  
 Accesorios incluidos en el set:
  - Panel de Puerta-ST20 (x1)
  - Riel Superior (x1)
  - Riel Inferior (x1)
  - Topes y accesorios relacionados
  - Ruedas y herrajes
- Accesorios no incluidos:
  - Poste Serie 40-Set (x3)
  - Cerradura (x1)
  - Panel Fijo-ST20 (x1)
  - Interruptor Enclavamiento Seguridad (x1)
- Image displays Door-Left Open (LHS)  
 Opening Width  $W_0$  = Panel Width  $W$  - 100mm  
 Standard accessories included:
  - Door Panel-ST20 (x1)
  - Lower Rail (x1)
  - Upper Rail (x1)
  - Door Stop and related accessories
  - Pulley unit
- Accessories not included:
  - 40 Series Post-Set (x3)
  - Lock (x1)
  - Fixed Panel-ST20 (x1)
  - Electronic Safety Switch (x1)

### Tipos de Cerradura Aplicables Applicable Lock Types



Cerradura de Goma  
LHS & RHS: 13 332 110

Rubber Door Handle  
LHS & RHS: 13 332 110



Cerradura de Llave  
LHS: 13 312 100  
RHS: 13 312 200

Key Lock  
LHS: 13 312 100  
RHS: 13 312 200



Cerradura de Seguridad  
LHS: 13 321 100  
RHS: 13 321 200

Safety Lock General Type  
LHS: 13 321 100  
RHS: 13 321 200

Altura H Height H	Ancho W Width W	Código L Product code L	Código R Product code R	Peso (kg) Weight (kg)
1800	700	13 231 210	13 232 210	13.1
	800	13 231 220	13 232 220	14.2
	1000	13 231 230	13 232 230	16.5
	1200	13 231 240	13 232 240	18.7
	1500	13 231 250	13 232 250	22.0
2200	700	13 231 310	13 232 310	14.4
	800	13 231 320	13 232 320	15.7
	1000	13 231 330	13 232 330	18.2
	1200	13 231 340	13 232 340	20.7
	1500	13 231 350	13 232 350	24.4

## Puerta Corrediza Doble Double Sliding Door

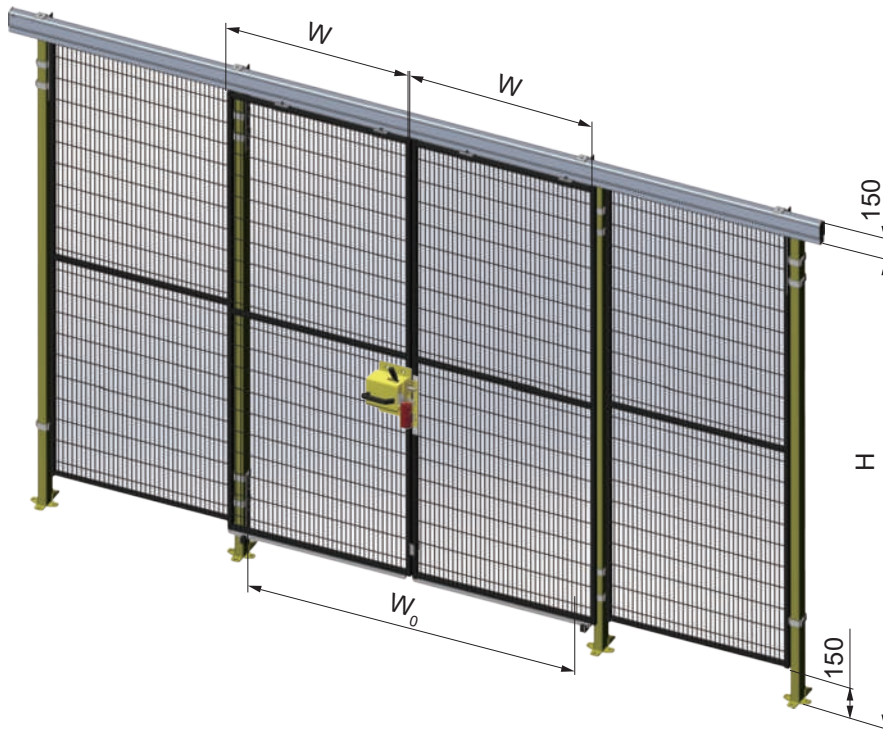

- Ancho de apertura  $W_0$  = Ancho panel  $W \times 2 - 200\text{mm}$

Accesorios incluidos en el set:

- Panel de Puerta-ST20 (x2)
- Riel Superior (x1)
- Riel Inferior (x2)
- Topes y accesorios relacionados
- Ruedas y herrajes

Accesorios no incluidos:

- Poste Serie 40-Set (x4)
- Panel Fijo-ST20 (x2)
- Cerradura (x1)
- Interruptor Enclavamiento Seguridad (x1)

- Opening Width  $W_0$  = Panel Width  $W \times 2 - 200\text{mm}$

Standard accessories included:

- Door Panel-ST20 (x2)
- Upper Rail (x1)
- Lower Rail (x2)
- Door Stop and related accessories
- Pulley unit

Accessories not included:

- 40 Series Post-Set (x4)
- Fixed Panel-ST20 (x2)
- Lock (x1)
- Electronic Safety Switch (x1)

Altura H Height H	Ancho W Width W	Código de producto Product code	Peso (kg) Weight (kg)
1800	700	13 241 210	24.2
	800	13 241 220	26.3
	1000	13 241 230	30.9
	1200	13 241 240	35.2
	1500	13 241 250	41.8
2200	700	13 241 310	26.8
	800	13 241 320	29.3
	1000	13 241 330	34.3
	1200	13 241 340	39.2
	1500	13 241 350	46.6

### Tipos de Cerradura Aplicables Applicable Lock Types



Cerradura de Goma  
Double: 13 332 310

Rubber Door Handle  
Double 13 332 310



Cerradura de Llave  
Double: 13 312 300

Key Lock  
Double: 13 312 300



Cerradura de Seguridad  
Double: 13 321 300

Safety Lock General Type  
Double: 13 321 300



## Puerta Plegable Simple de 2 Hojas Single Folding Door Two Leaves

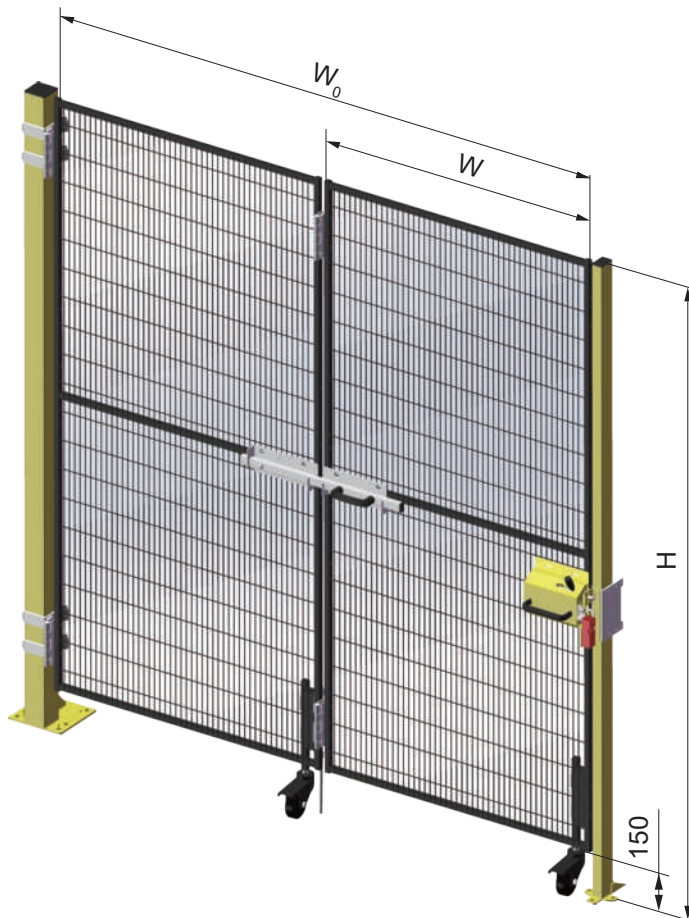

### Tipos de Cerradura Aplicables Applicable Lock Types



Cerradura Magnética  
LHS & RHS: 13 331 120



Cerradura de Llave  
LHS: 13 311 100  
RHS: 13 311 200

Magnetic Door Handle  
LHS & RHS: 13 331 120

Key Lock  
LHS: 13 311 100  
RHS: 13 311 200



Cerradura de Seguridad  
LHS: 13 322 100  
RHS: 13 322 200

Safety Lock General Type  
LHS: 13 322 100  
RHS: 13 322 200

- Imagen muestra Puerta-Apertura Izq (LHS)  
Ancho de apertura  $W_0$  = Ancho de panel  $W \times 2 + 60\text{mm}$   
Accesorios incluidos en el set:
  - Panel de Puerta-ST20 (x2)
  - Pasador de Puerta (x1)
  - Bisagras y Accesorios
  - Ruedas giratorias (x2)
  - Pasador a piso (x1)
- Accesorios no incluidos:
  - Poste Serie 40-Set (x1)
  - Cerradura (x1)
  - Poste Serie 80-Set (x1)
  - Interruptor Enclavamiento Seguridad (x1)

- Image displays Door-Left Open (LHS)  
Opening Width  $W_0$  = Panel Width  $W \times 2 + 60\text{mm}$   
Standard accessories included:
  - Door Panel-ST20 (x2)
  - Door Latch (x1)
  - Hinges and accessories
  - Castor Wheels (x2)
  - Ground Latch (x1)
- Accessories not included:
  - 40 Series Post-Set (x1)
  - Lock (x1)
  - 80 Series Post-Set (x1)
  - Electronic Safety Switch (x1)

Altura H Height H	Ancho W Width W	Código L Product code L	Código R Product code R	Peso (kg) Weight (kg)
1400	800	13 251 120	13 252 120	17.3
	1000	13 251 130	13 252 130	19.5
	1200	13 251 140	13 252 140	20.9
1800	800	13 251 220	13 252 220	20.1
	1000	13 251 230	13 252 230	23.1
	1200	13 251 240	13 252 240	25.6
2200	800	13 251 320	13 252 320	23.1
	1000	13 251 330	13 252 330	26.5
	1200	13 251 340	13 252 340	29.6

## Puerta Plegable Simple de 3 Hojas Single Folding Door Three Leaves

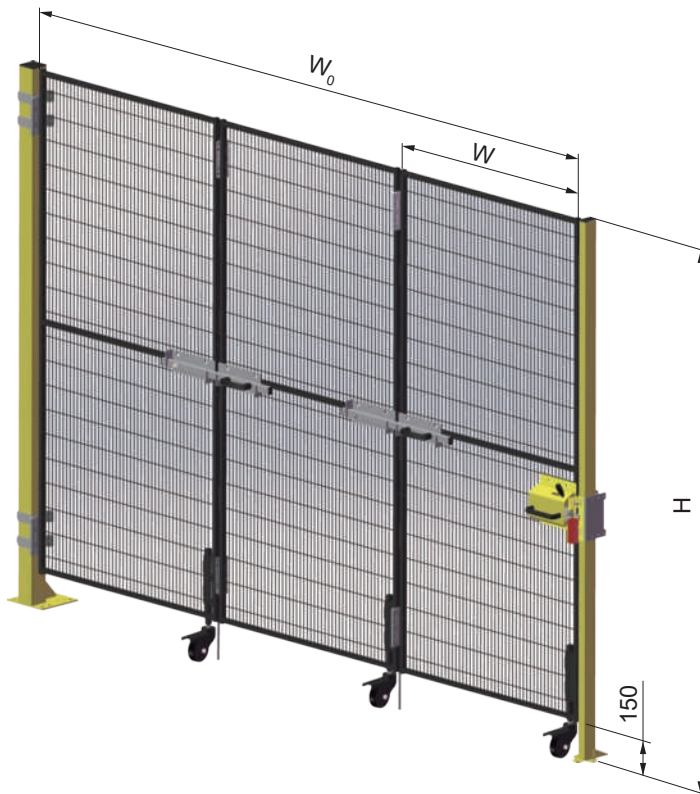

- Imagen muestra Puerta-Apertura Izq (LHS)  
 Ancho de apertura  $W_0$  = Ancho de panel  $W \times 3 + 78\text{mm}$   
 Accesorios incluidos en el set:
    - Panel de Puerta-ST20 (x3)
    - Pasador de Puerta (x2)
    - Bisagras y Accesorios
    - Ruedas giratorias (x3)
    - Pasador a piso (x2)
- Accesorios no incluidos:
- Poste Serie 40-Set (x1)
  - Cerradura (x1)
  - Poste Serie 80-Set (x1)
  - Interruptor Enclavamiento Seguridad (x1)

- Image displays Door-Left Open (LHS)  
 Opening Width  $W_0$  = Panel Width  $W \times 3 + 78\text{mm}$   
 Standard accessories included:
    - Door Panel-ST20 (x3)
    - Door Latch (x2)
    - Hinges and accessories
    - Castor Wheels (x3)
    - Ground Latch (x2)
- Accessories not included:
- 40 Series Post-Set (x1)
  - Lock (x1)
  - 80 Series Post-Set (x1)
  - Electronic Safety Switch (x1)

### Tipos de Cerradura Aplicables Applicable Lock Types



Cerradura Magnética  
LHS & RHS: 13 331 120



Cerradura de Llave  
LHS: 13 311 100  
RHS: 13 311 200

Magnetic Door Handle  
LHS & RHS: 13 331 120

Key Lock  
LHS: 13 311 100  
RHS: 13 311 200



Cerradura de Seguridad  
LHS: 13 322 100  
RHS: 13 322 200

Safety Lock General Type  
LHS: 13 322 100  
RHS: 13 322 200

Altura H Height H	Ancho W Width W	Código L Product code L	Código R Product code R	Peso (kg) Weight (kg)
1400	800	13 253 120	13 254 120	44.2
	1000	13 253 130	13 254 130	47.5
	1200	13 253 140	13 254 140	51.1
1800	800	13 253 220	13 254 220	48.4
	1000	13 253 230	13 254 230	52.9
	1200	13 253 240	13 254 240	57.1
2200	800	13 253 320	13 254 320	52.9
	1000	13 253 330	13 254 330	58.0
	1200	13 253 340	13 254 340	63.1



## Puerta Plegable Doble Bi-folding Door

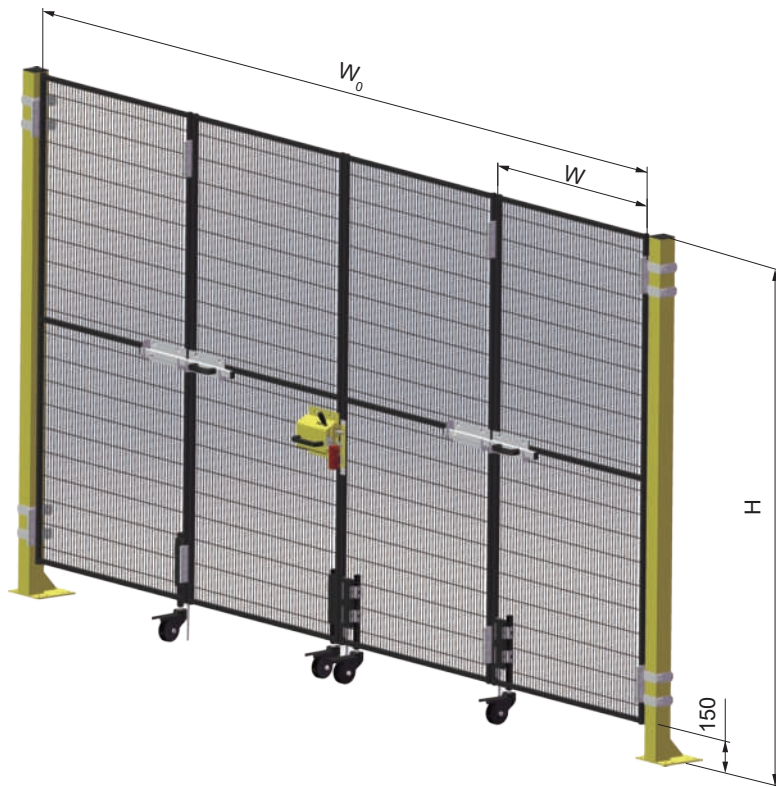

### Tipos de Cerradura Aplicables Applicable Lock Types



Cerradura de Llave  
Double: 13 311 300

Key Lock  
Double: 13 311 300



Cerradura de Seguridad  
Double: 13 321 300

Safety Lock General Type  
Double: 13 321 300

- Imagen muestra Puerta-Apertura Izq (LHS)  
Ancho de apertura  $W_0$  = Ancho de panel  $W*4 + 102\text{mm}$   
Accesorios incluidos en el set:
  - Panel de Puerta-ST20 (x4)
  - Pasador de Puerta (x2)
  - Bisagras y Accesorios
  - Ruedas giratorias (x4)
  - Pasador a piso (x3)
- Accesorios no incluidos:
  - Poste Serie 80-Set (x2)
  - Cerradura (x1)
  - Interruptor Enclavamiento Seguridad (x1)

- Image displays Door-Left Open (LHS)  
Opening Width  $W_0$  = Panel Width  $W*4 + 102\text{mm}$   
Standard accessories included:
  - Door Panel-ST20 (x4)
  - Door Latch (x2)
  - Hinges and accessories
  - Castor Wheels (x4)
  - Ground Latch (x3)
- Accessories not included:
  - 80 Series Post-Set (x2)
  - Lock (x1)
  - Electronic Safety Switch (x1)

Altura H Height H	Ancho H Width H	Código de producto Product code	Peso (kg) Weight (kg)
1400	800	13 261 120	53.0
	1000	13 261 130	56.3
	1200	13 261 140	59.9
1800	800	13 261 220	57.2
	1000	13 261 230	61.7
	1200	13 261 240	65.9
2200	800	13 261 320	61.7
	1000	13 261 330	66.9
	1200	13 261 340	76.7

## Puerta Telescópica Simple

### Single Telescopic Door

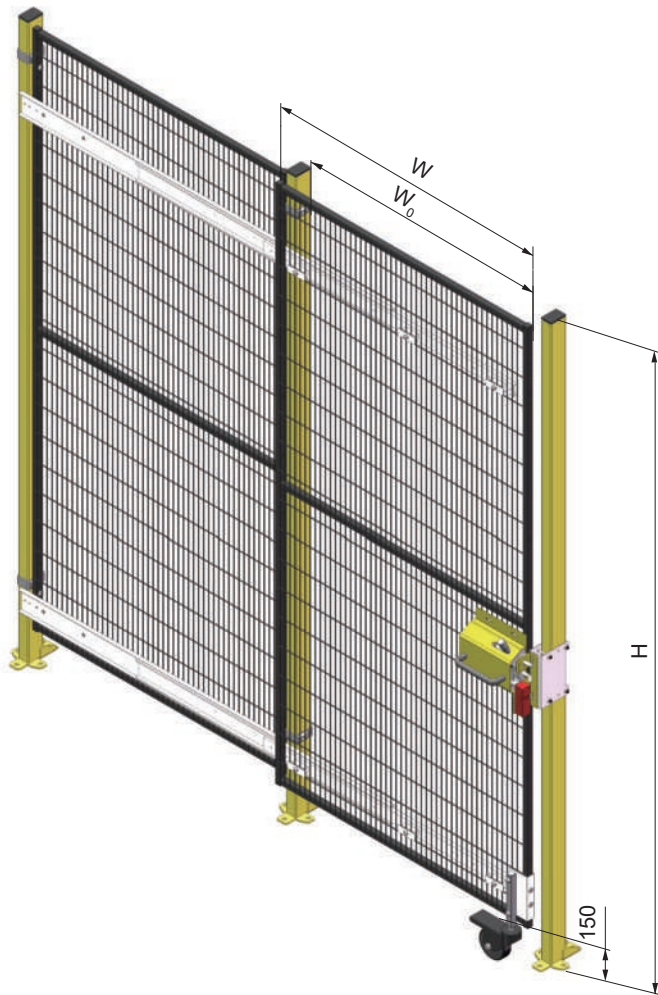

#### Tipos de Cerradura Aplicables

##### Applicable Lock Types



Cerradura de Goma  
LHS & RHS: 13 332 110

Rubber Door Handle  
LHS & RHS: 13 332 110



Cerradura de Llave  
LHS: 13 312 100  
RHS: 13 312 200

Key Lock  
LHS: 13 312 100  
RHS: 13 312 200



Cerradura de Seguridad  
LHS: 13 321 100  
RHS: 13 321 200

Safety Lock General Type  
LHS: 13 321 100  
RHS: 13 321 200

- Imagen muestra Puerta-Apertura Izq (LHS)  
Ancho de apertura  $W_0$  = Ancho de panel  $W$  - 30mm  
Accesorios incluidos en el set:
  - Panel de Puerta-ST20 (x1)
  - Riel Telescópico Inf (x1)
  - Riel Telescópico Sup (x1)
  - Topes y accesorios relacionados
  - Rueda giratoria (x1)
- Accesorios no incluidos:
  - Poste Serie 40-Set (x3)
  - Cerradura (x1)
  - Panel Fijo-ST20 (x1)
  - Interruptor Enclavamiento Seguridad (x1)

- Image displays Door-Left Open (LHS)  
Opening Width  $W_0$  = Panel Width  $W$  - 30mm  
Standard accessories included:
  - Door Panel-ST20 (x1)
  - Lower Telescopic Rail (x1)
  - Upper Telescopic Rail (x1)
  - Door Stop and related accessories
  - Castor Wheel (x1)
- Accessories not included:
  - 40 Series Post-Set (x3)
  - Lock (x1)
  - Fixed Panel-ST20 (x1)
  - Electronic Safety Switch (x1)

Altura H Height H	Ancho W Width W	Código L Product code L	Código R Product code R	Peso (kg) Weight (kg)
1400	1000	13 271 110	13 272 110	30.2
	1200	13 271 120	13 272 120	35.5
	1500	13 271 130	13 272 130	46.7
1800	1000	13 271 210	13 272 210	32.0
	1200	13 271 220	13 272 220	37.5
2200	1500	13 271 230	13 272 230	49.1
	1000	13 271 310	13 272 310	33.7
	1200	13 271 320	13 272 320	39.5
	1500	13 271 330	13 272 330	51.5



## Puerta Telescópica Doble Double Telescopic Door

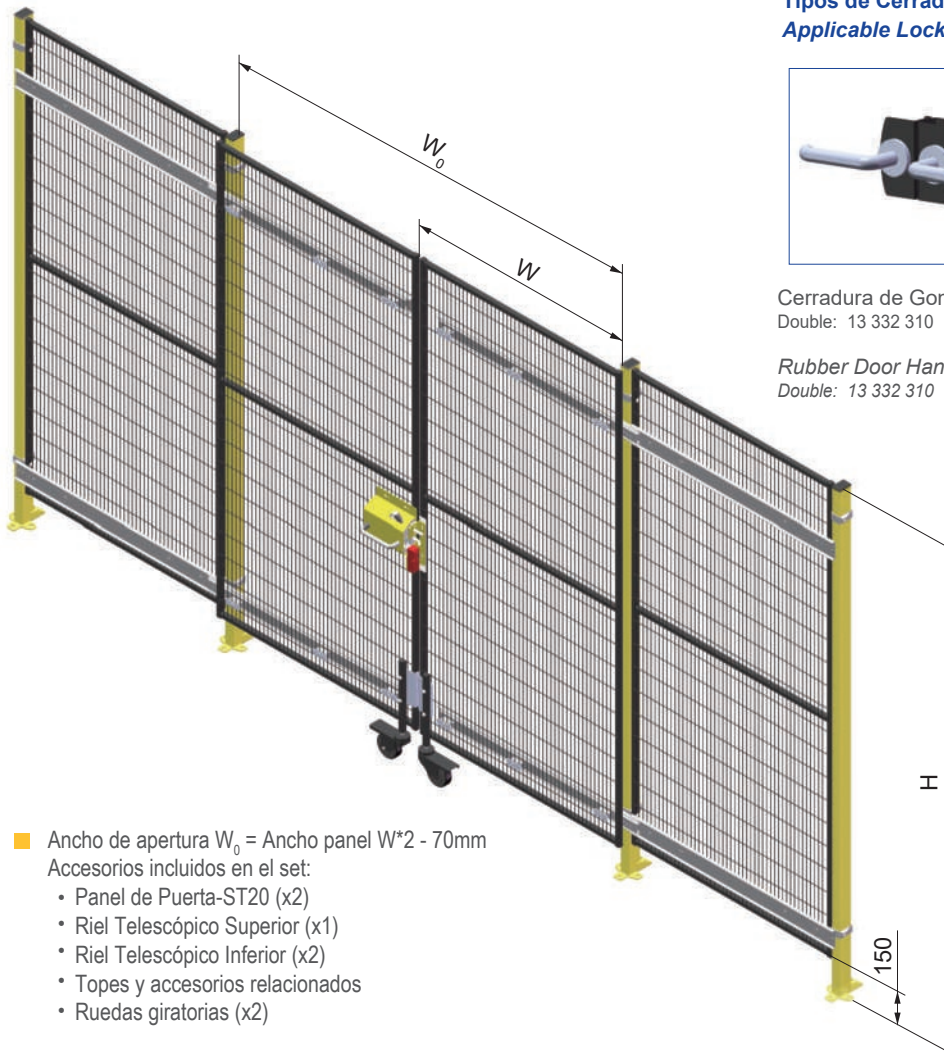

- Ancho de apertura  $W_0$  = Ancho panel  $W \times 2 - 70\text{mm}$   
 Accesorios incluidos en el set:
  - Panel de Puerta-ST20 (x2)
  - Riel Telescópico Superior (x1)
  - Riel Telescópico Inferior (x2)
  - Topes y accesorios relacionados
  - Ruedas giratorias (x2)

Accesorios no incluidos:

- Poste Serie 40-Set (x4)
- Panel Fijo-ST20 (x2)
- Cerradura (x1)
- Interruptor Enclavamiento Seguridad (x1)

- Opening Width  $W_0$  = Panel Width  $W \times 2 - 70\text{mm}$   
 Standard accessories included:
  - Door Panel-ST20 (x2)
  - Upper Telescopic Rail (x1)
  - Lower Telescopic Rail (x2)
  - Door Stop and related accessories
  - Castor Wheel (x2)

Accessories not included:

- 40 Series Post-Set (x4)
- Fixed Panel-ST20 (x2)
- Lock (x1)
- Electronic Safety Switch (x1)

### Tipos de Cerradura Aplicables Applicable Lock Types



Cerradura de Goma  
Double: 13 332 310

Rubber Door Handle  
Double: 13 332 310



Cerradura de Llave  
Doble: 13 312 300

Key Lock  
Double: 13 312 300



Cerradura de Seguridad  
Doble: 13 321 300

Safety Lock General Type  
Double: 13 321 300

Altura H Height H	Ancho W Width W	Código de producto Product code	Peso (kg) Weight (kg)
1400	1000	13 281 110	40.4
	1200	13 281 120	46.9
	1500	13 281 130	59.8
1800	1000	13 281 210	44.0
	1200	13 281 220	50.9
	1500	13 281 230	64.6
2200	1000	13 281 310	47.4
	1200	13 281 320	54.9
	1500	13 281 330	69.4



Aplicaciones  
Applications







Alutipo SRL  
Web: [www.alutipo.com](http://www.alutipo.com)  
Email: [info@alutipo.com](mailto:info@alutipo.com)



**Sistema de Cerramientos de Seguridad**  
*Safety Fencing System*